

1 2 3 4 5 6

A

A

B

B

C

C

D

D

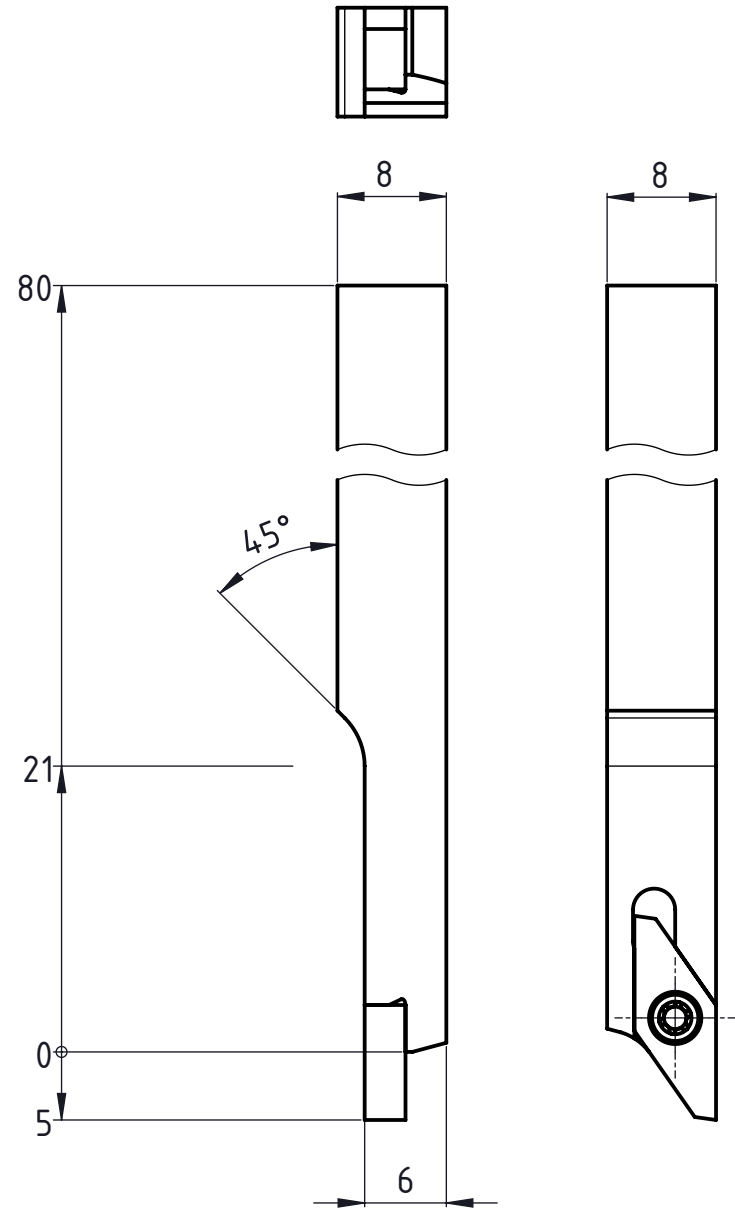
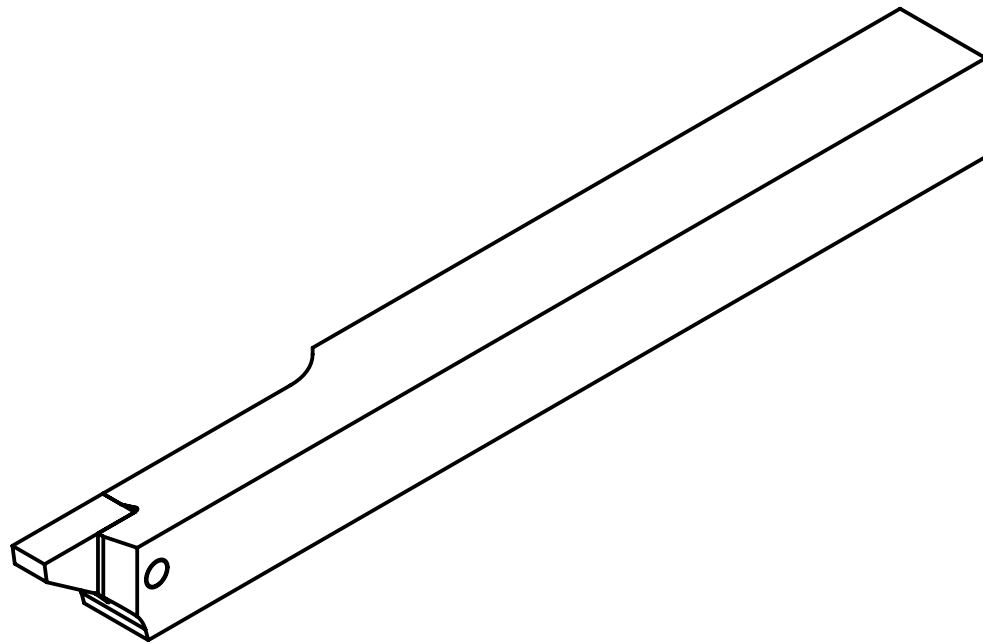

Rechte Ausführung
 Execution droite
 Right execution



Freigegeben von am
 T.Weilenmann am 12.02.2018
 erstellt von am
 T.Weilenmann am 12.02.2018

Beschreibung
 Multidec Cut Halter
 Artikel Bezeichnung
 1600-08x80LA

Zeichnungsnummer
 CUT-129-28

