

1 2 3 4 5 6

A

B

C

D

A

B

C

D

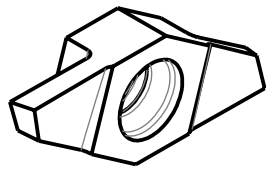
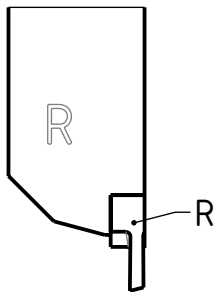
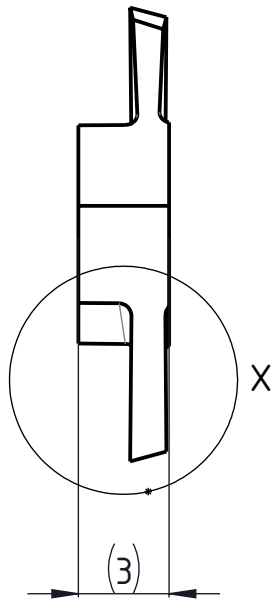
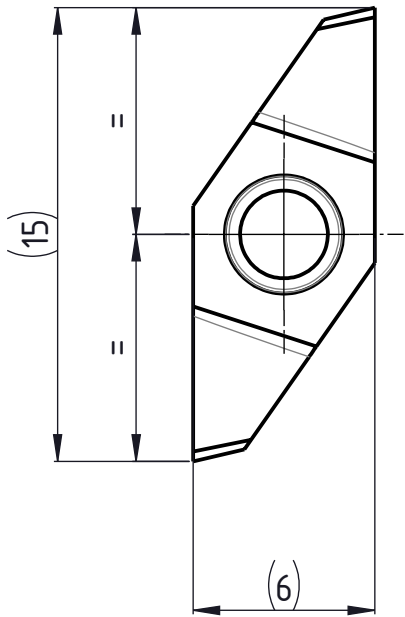

X (10 : 1)

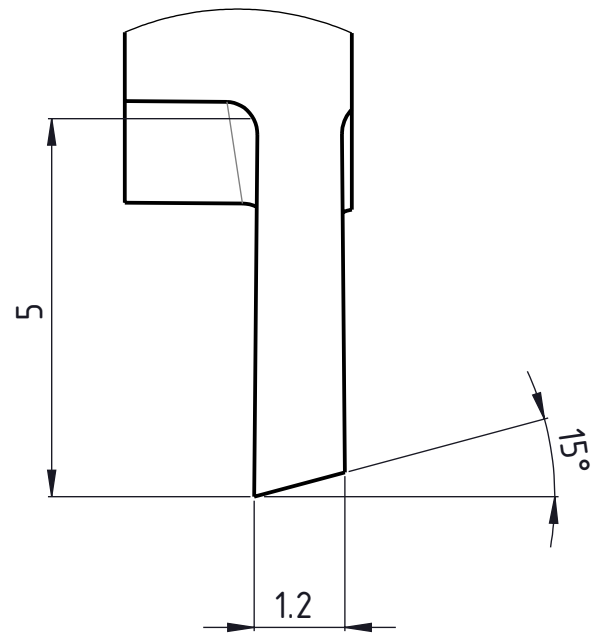

Rechte Ausführung
 Execution droite
 Right execution

Beschreibung
multidec CUT-Wendeplatte

Artikel Bezeichnung
1602-1.2-5 R

Zeichnungsnummer
CUT-1602-01-07

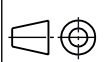

Index
 -