

1 2 3 4 5 6

A

A

B

B

C

C

D A4-Kunde-V6

D

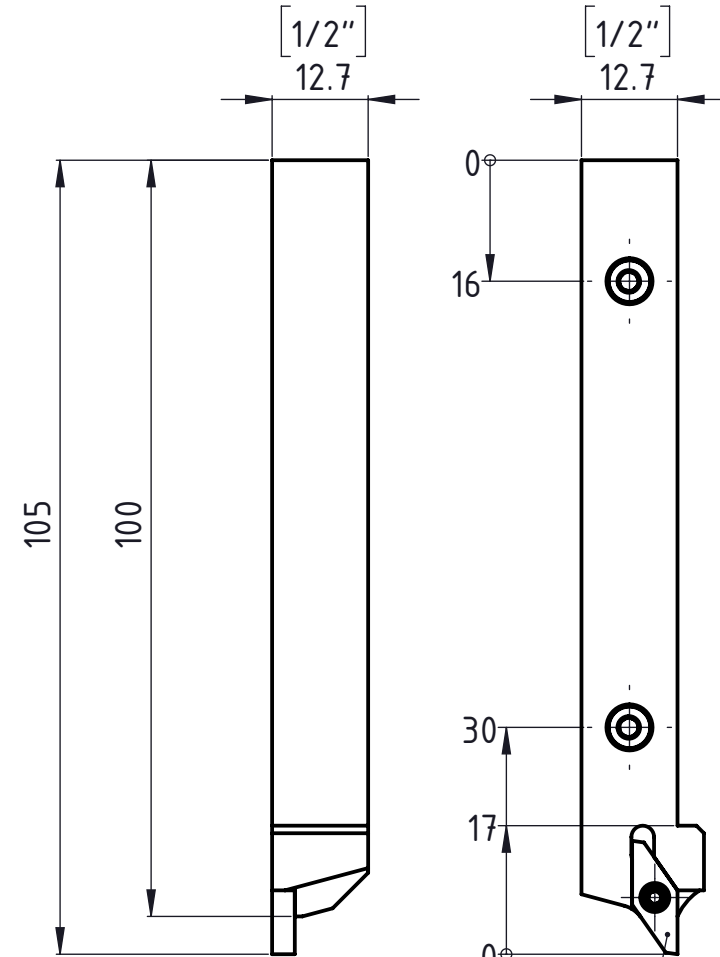
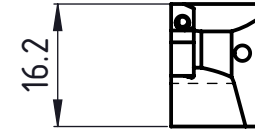
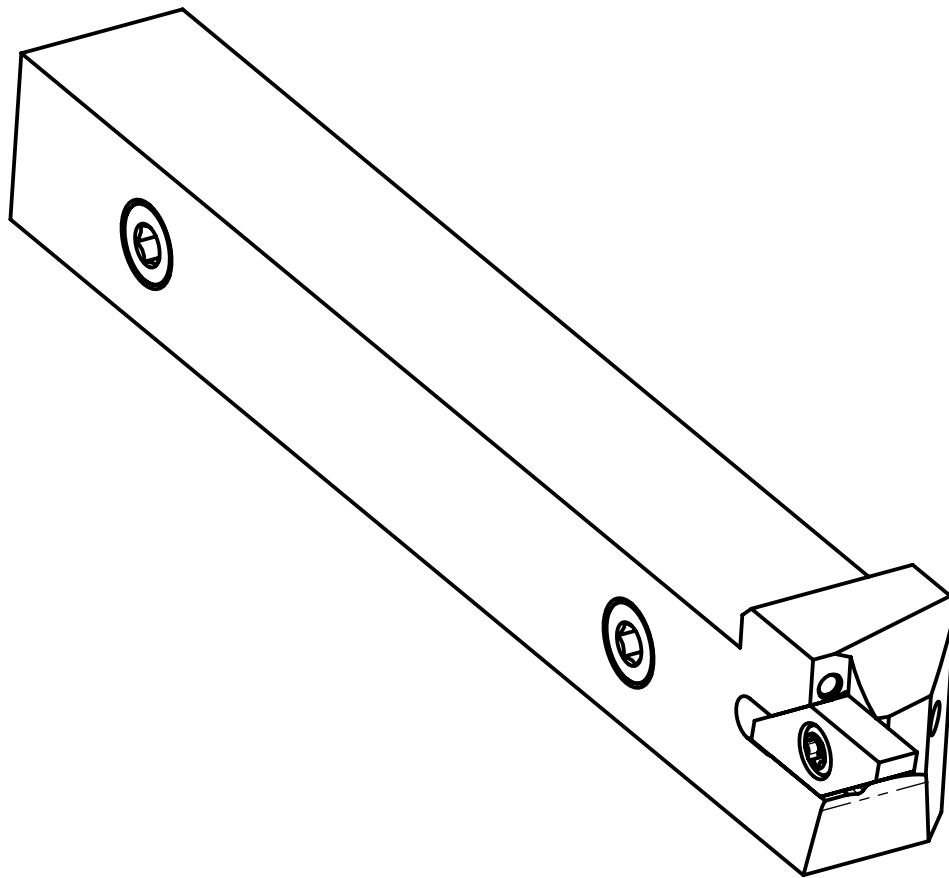

Freigegeben von am
T.Weilenmann am 05.02.2018
 erstellt von am
C.Fabozzi am 15.02.2013

Beschreibung
UTILIS Multidec-Cut Halter
 Artikel Bezeichnung
1600-1/2"x100 L IC

Zeichnungsnummer
CUT-199-13

