

1 2 3 4 5 6

A

A

B

B

C

C

D

D

A4-Kunde V7

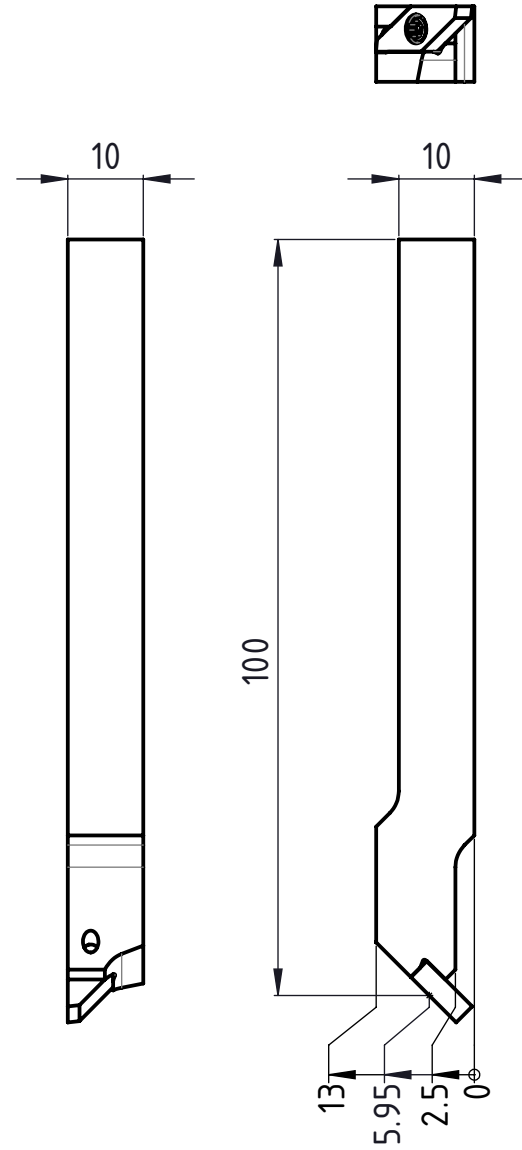
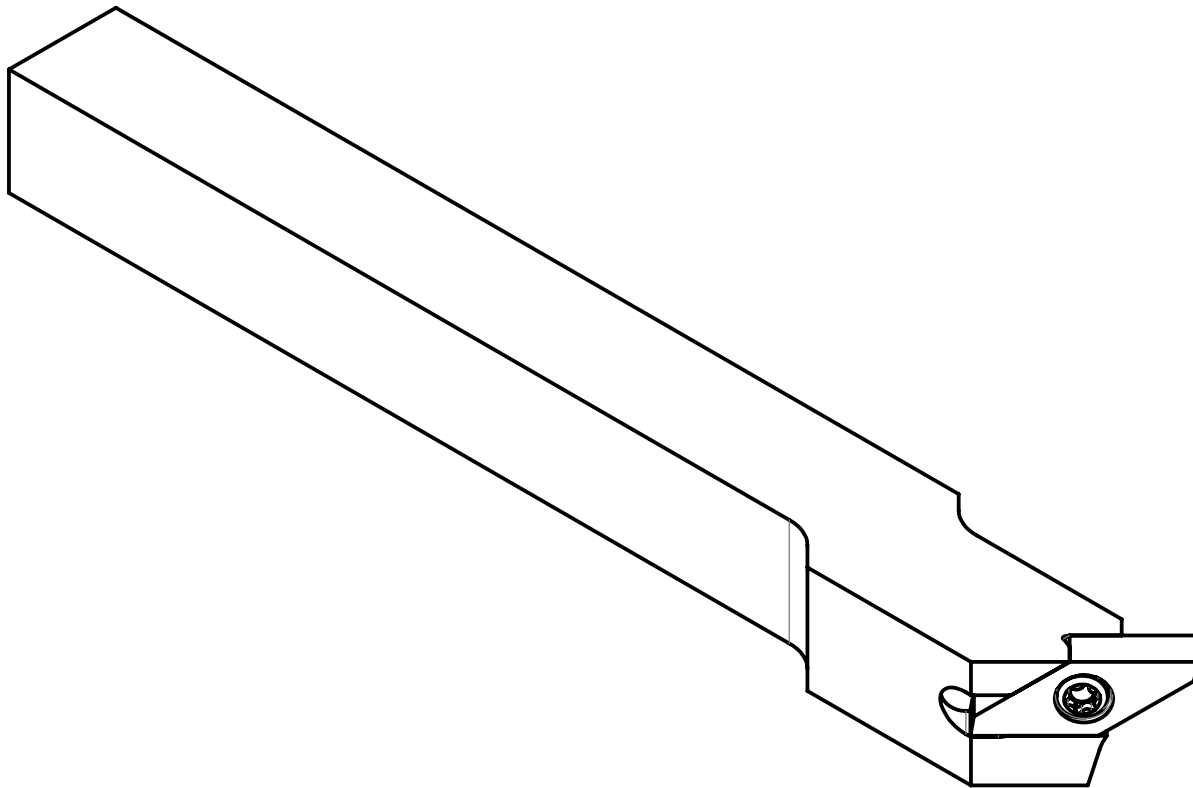

Freigegeben von am

C.Fabozzi am 22.07.2019

erstellt von am

C.Fabozzi am 15.07.2014

Beschreibung

multidec Cut Halter

Artikel Bezeichnung

1600-10x100 45 ST RA

**UTILIS**<sup>®</sup>

*Tooling for High Technology*

Zeichnungsnummer

CUT-416-01-04



A4

Index

B