

1 2 3 4 5 6

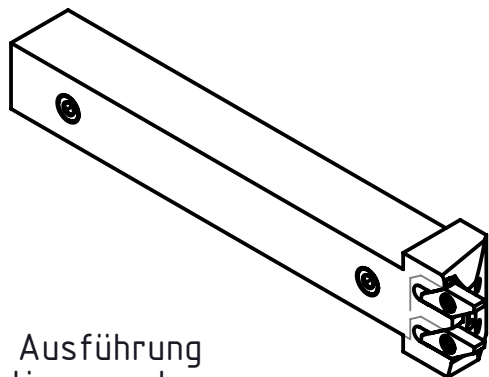

Linke Ausführung
Execution gauche
Left execution

D A4-Kunde-V5

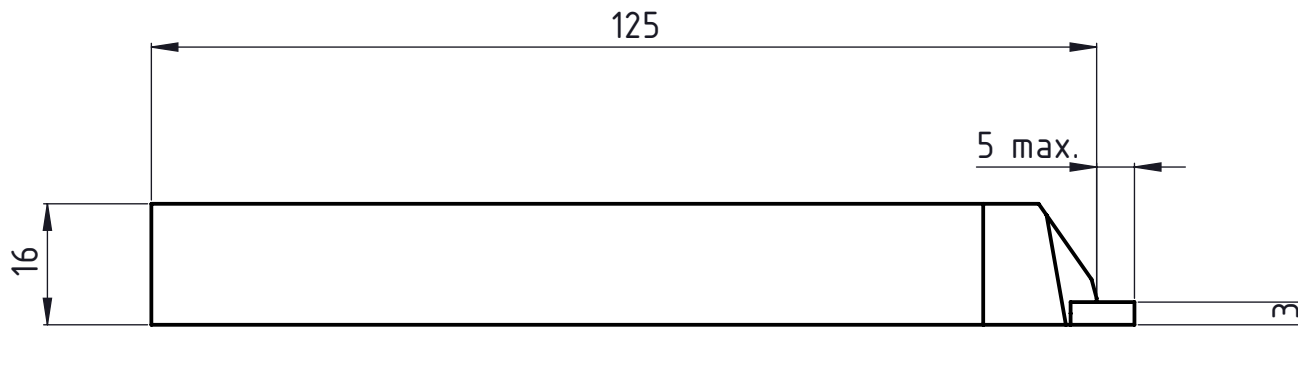
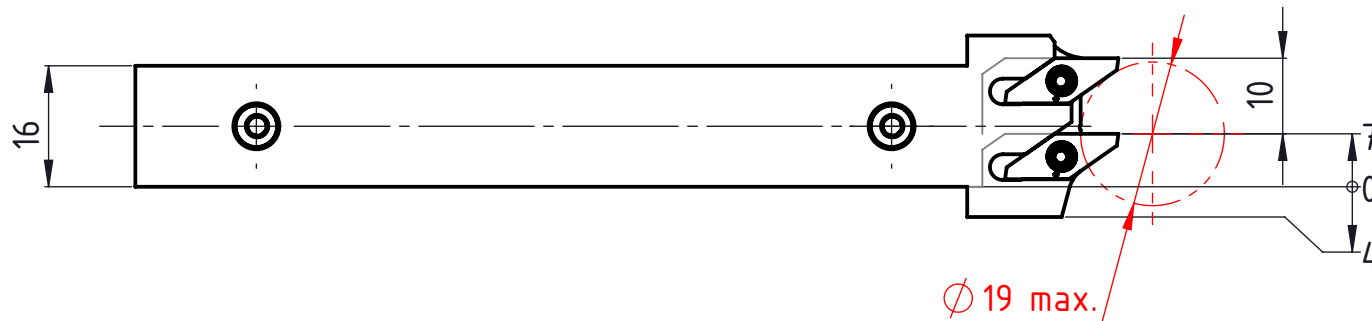
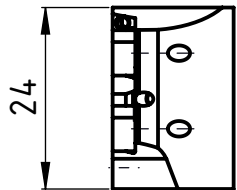

Freigegeben von am
C. Fabozzi am 11.01.2017
erstellt von am
C. Fabozzi am 11.01.2017

Beschreibung
Multidec Twin Halter
Artikel Bezeichnung
1600L/1600L-16x125 IC Twin

Artikel Nr.
153628

Zeichnungsnummer
CUT-695-15

