

1 2 3 4 5 6

A

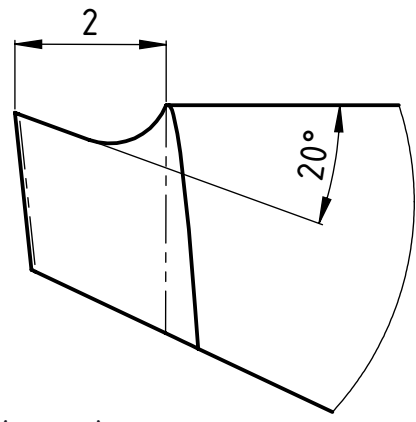
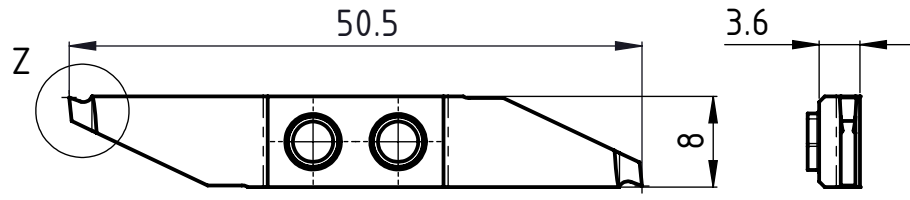

Z (10 : 1)

B

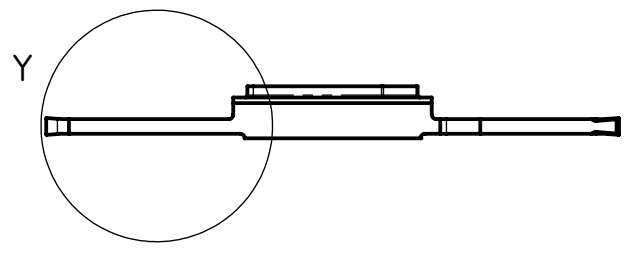

C

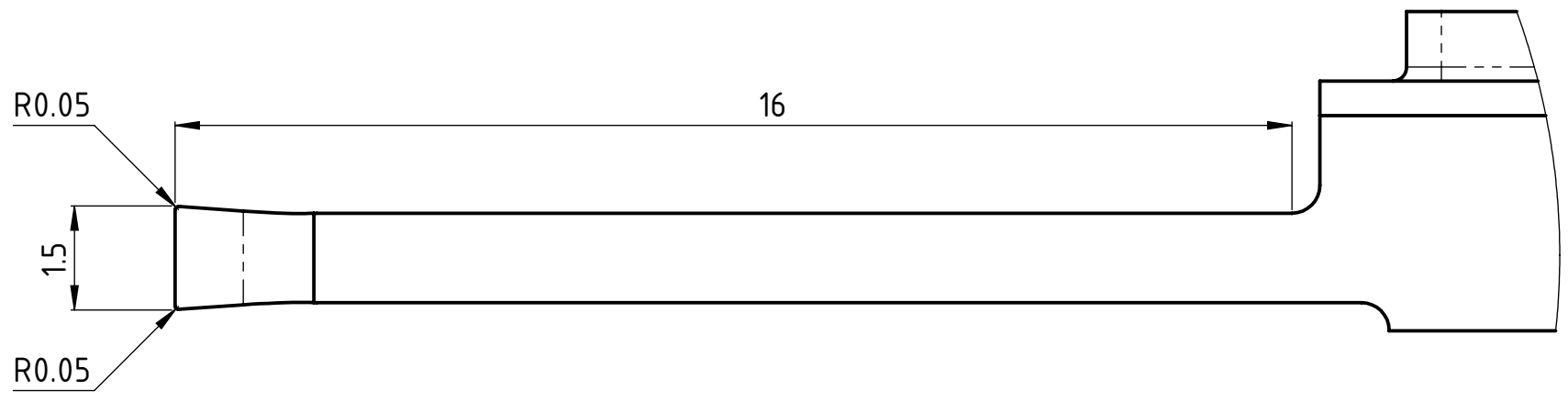

Y (10 : 1)

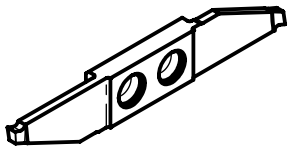

D



Slim+Deep

Rechte Ausführung
Execution droite
Right execution

A4-Kunde V7

Freigegeben von am E.Rahimi am 25.10.2018	Beschreibung Multidec CUT-Wendplatte	 Tooling for High Technology Zeichnungsnummer	 A4 Index
erstellt von am A. Munishi am 14.09.2018	Artikel Bezeichnung 3002-1.5-16 RN SPT	CUT-1071-01	-