

1 2 3 4 5 6

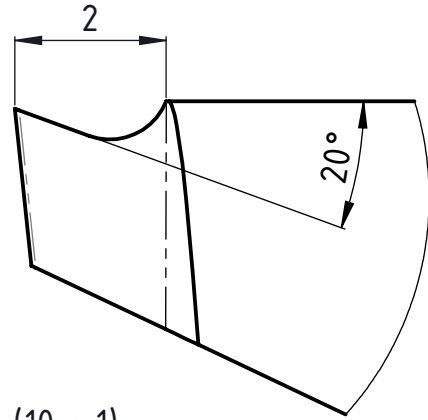

Z (10 : 1)

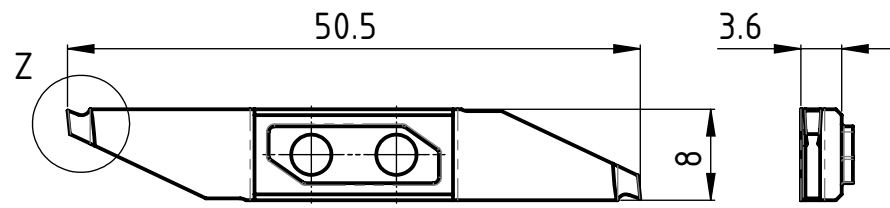

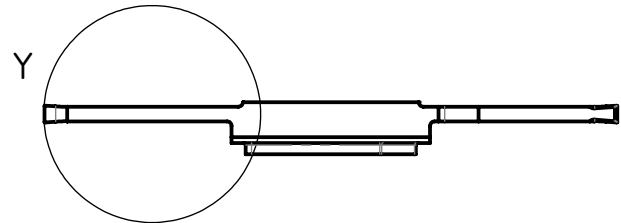

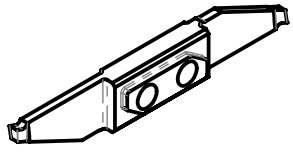
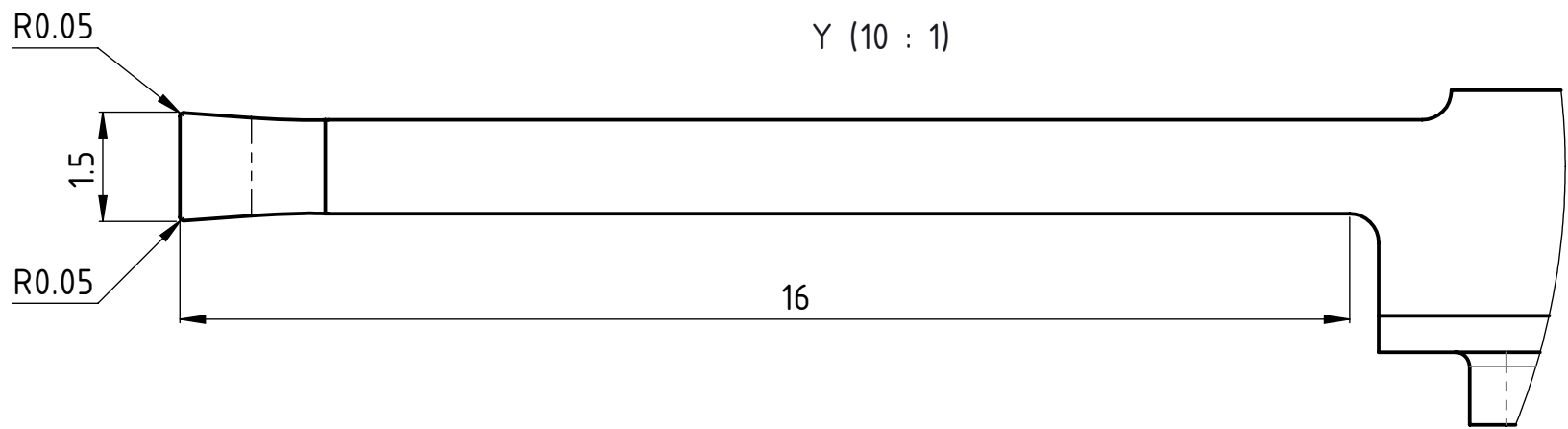
Y (10 : 1)



Slim+Deep

Linke Ausführung  
Execution gauche  
Left execution

B  
C  
D  
A4-Kunde V7

Freigegeben von am <b>E.Rahimi am 07.11.2018</b>	Beschreibung <b>Multidec CUT-Wendplatte</b>	 Tooling for High Technology Zeichnungsnummer	 A4 Index
erstellt von am <b>A. Munishi am 14.09.2018</b>	Artikel Bezeichnung <b>3002-1.5-16 LN SPT</b>	<b>CUT-1071-02</b>	-