

1 2 3 4 5 6

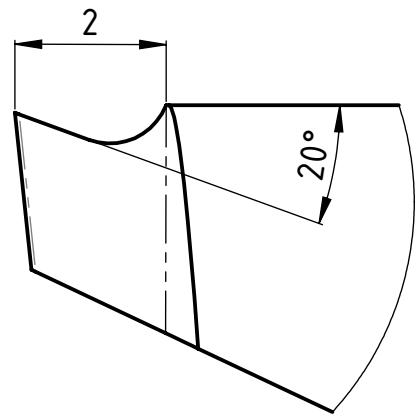

Z (10 : 1)

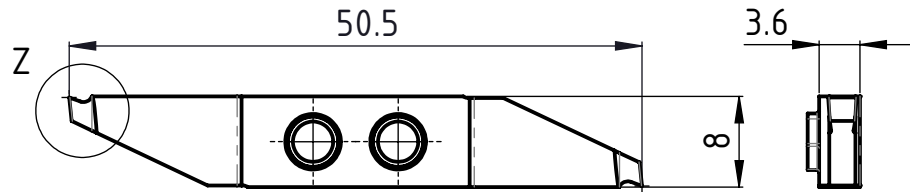

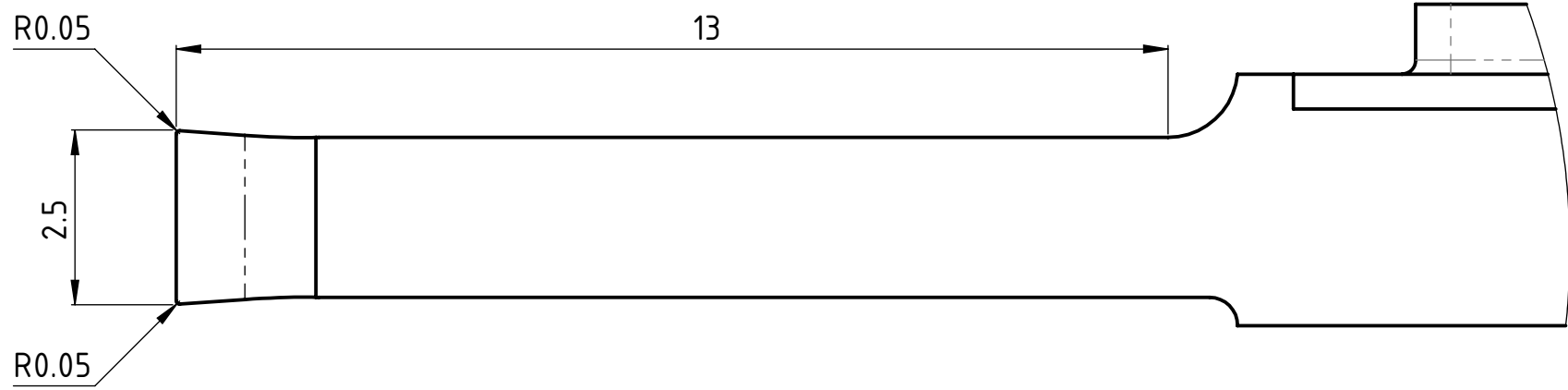
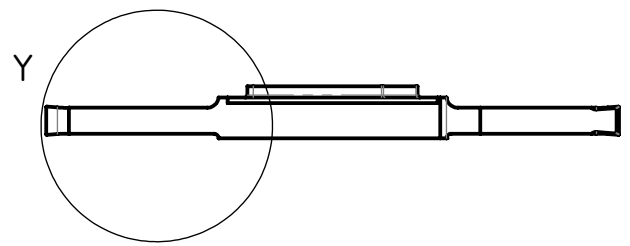

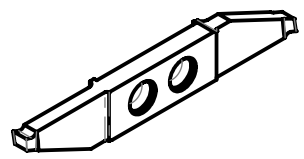
Y (10 : 1)



Rechte Ausführung  
Execution droite  
Right execution

A4-Kunde V7

Freigegeben von am <b>E.Rahimi am 22.11.2018</b>	Beschreibung <b>Multidec CUT-Wendepatte</b>	 Tooling for High Technology Zeichnungsnummer	 A4 Index
erstellt von am <b>A. Munishi am 01.10.2018</b>	Artikel Bezeichnung <b>3002-2.5-13 RN SPT</b>	<b>CUT-1071-13</b>	-