

1 2 3 4 5 6

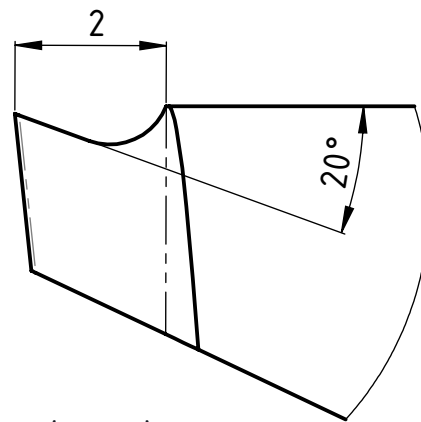

Z (10 : 1)

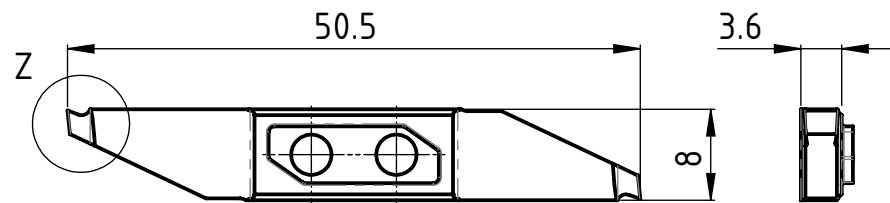

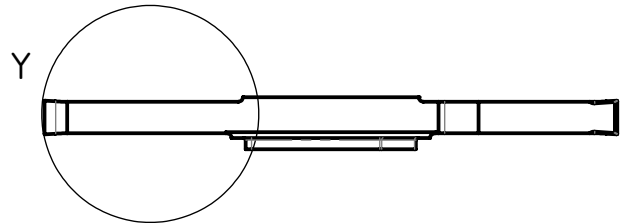

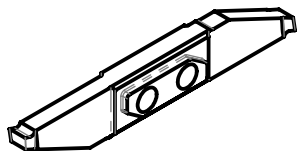
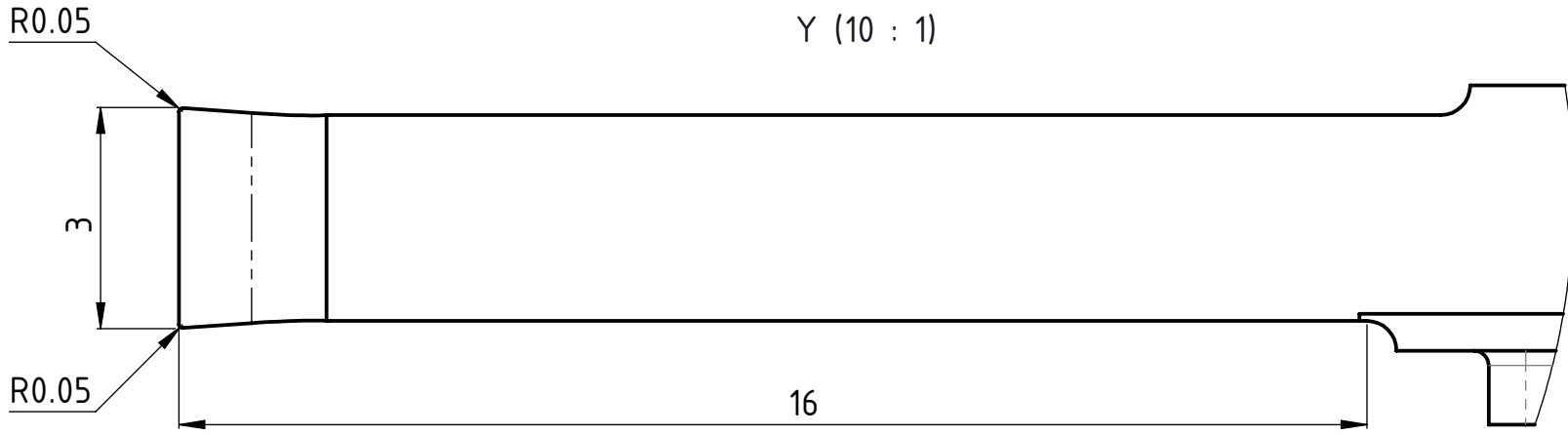
Y (10 : 1)



Linke Ausführung
 Execution gauche
 Left execution

A4-Kunde V7

Freigegeben von am E.Rahimi am 22.11.2018	Beschreibung Multidec CUT-Wendplatte	 <small>Tooling for High Technology</small> Zeichnungsnummer	 A4 Index
erstellt von am A. Munishi am 01.10.2018	Artikel Bezeichnung 3002-3.0-16 LN SPT	CUT-1071-16	-