

A

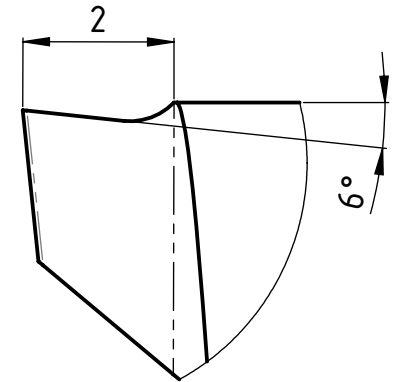

Z (10 : 1)

B

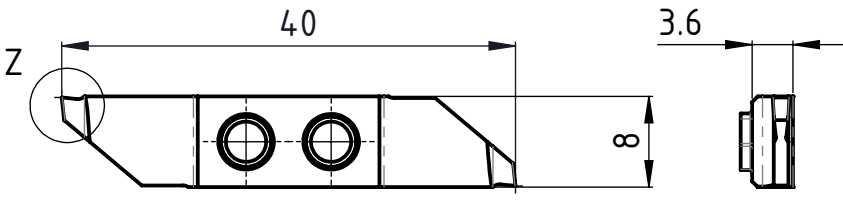
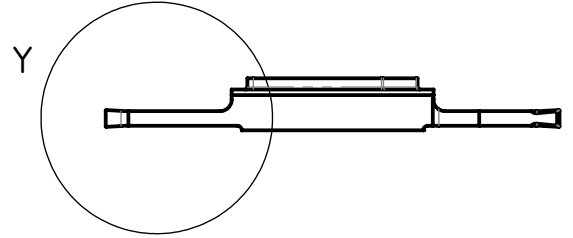

C

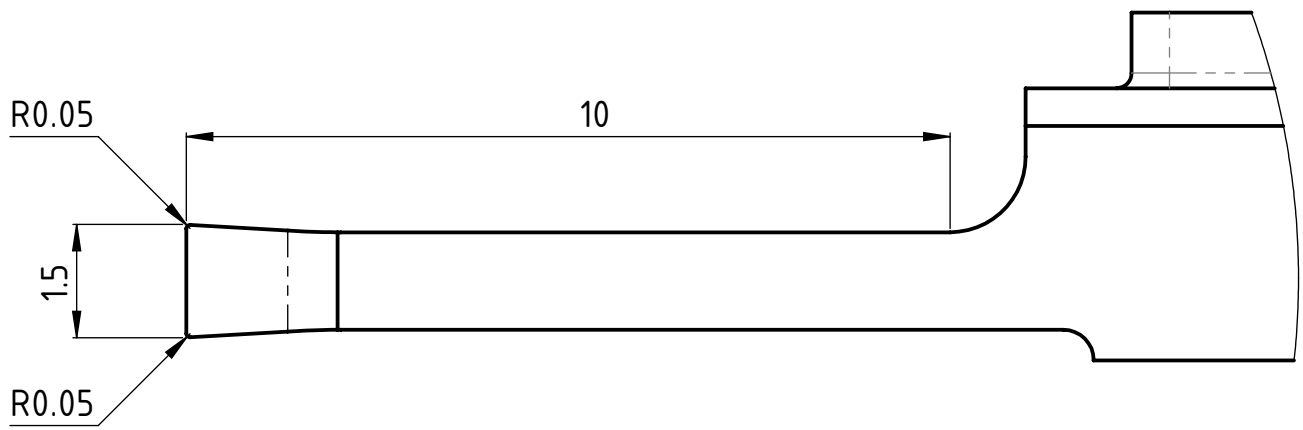

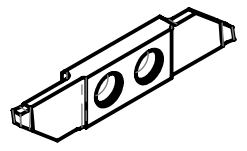

Y (10 : 1)

D



Rechte Ausführung
Execution droite
Right execution

A4-Kunde V7

Freigegeben von am E.Rahimi am 07.11.2018	Beschreibung Multidec CUT-Wendplatte	 Tooling for High Technology Zeichnungsnummer CUT-1071-17	 A4 Index -
erstellt von am A. Munishi am 01.10.2018	Artikel Bezeichnung 3002-1.5-10 RN SPT06	-	