

1 2 3 4 5 6

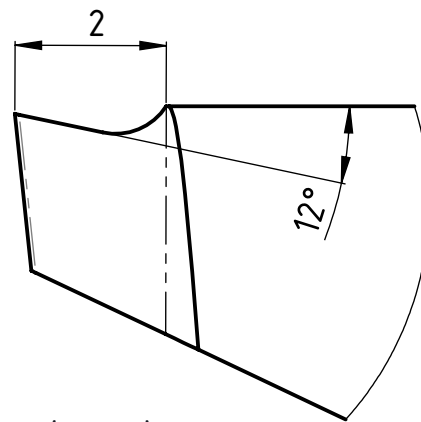

Z (10 : 1)

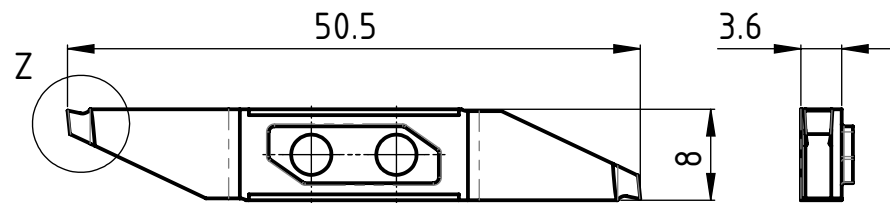
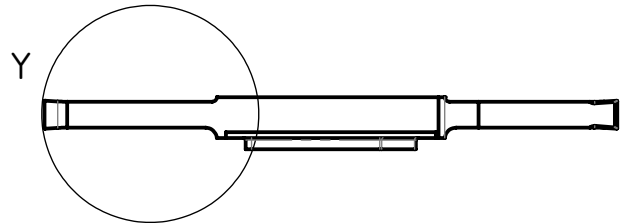

Y (10 : 1)

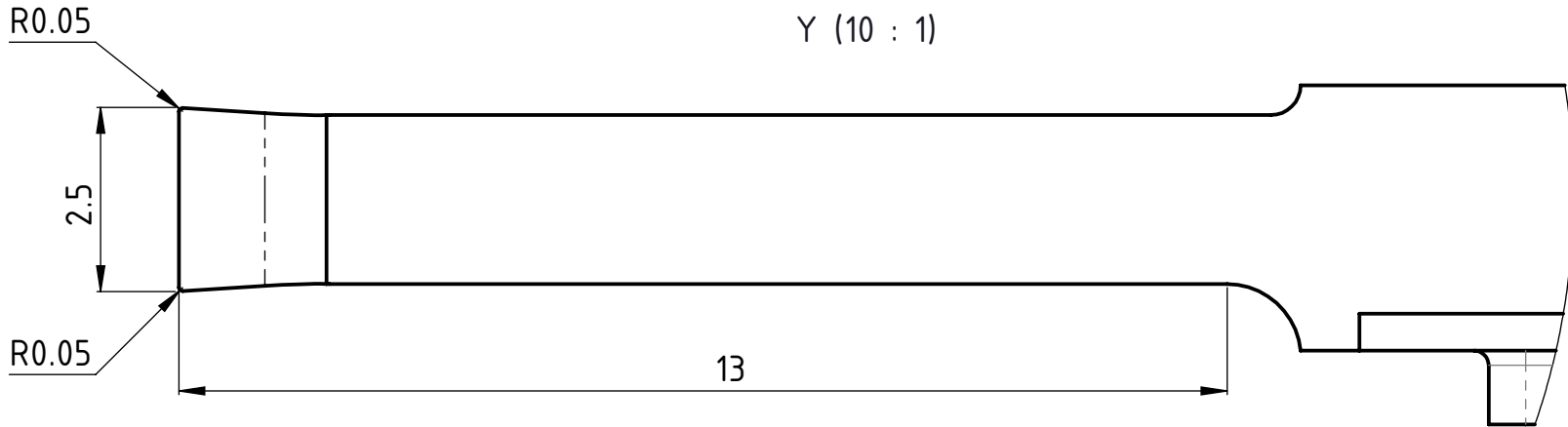

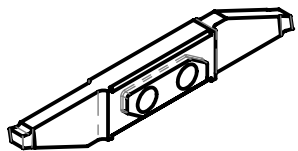

A
B
C
D
A4-Kunde V7

A
B
C
D



Linke Ausführung
Execution gauche
Left execution

Freigegeben von am T.Weilenmann am 12.11.2018	Beschreibung Multidec CUT-Wendepatte	 <small>Tooling for High Technology</small> Zeichnungsnummer	 A4 Index
erstellt von am A. Munishi am 02.10.2018	Artikel Bezeichnung 3002-2.5-13 LN SPT12	CUT-1071-32	-