

A

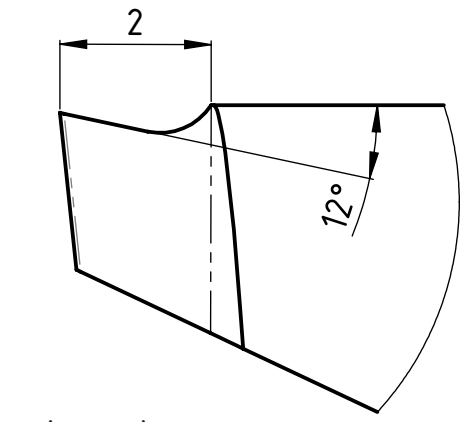

Z (10 : 1)

B

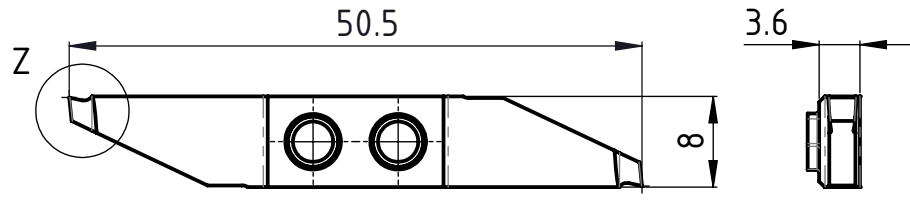
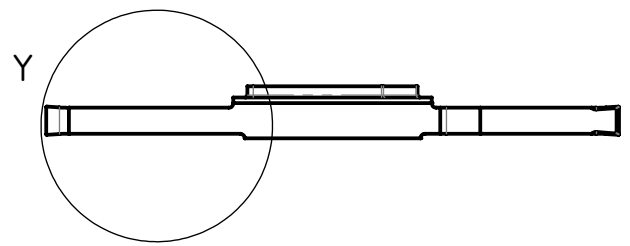

C

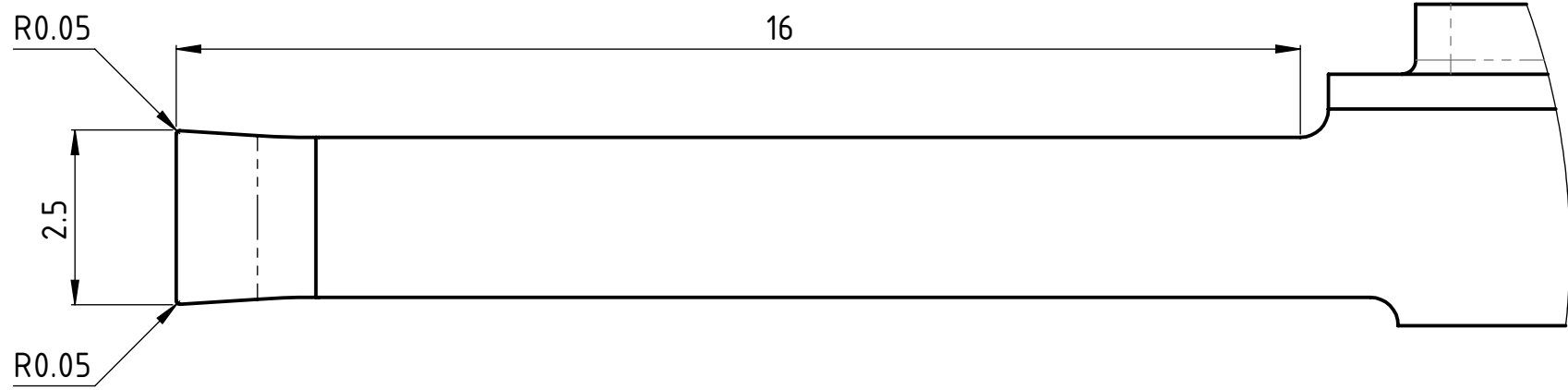

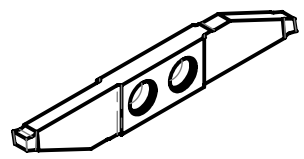

Y (10 : 1)

D



Rechte Ausführung
Execution droite
Right execution

A4-Kunde V7

Freigegeben von am T.Weilenmann am 12.11.2018	Beschreibung Multidec CUT-Wendplatte	 Tooling for High Technology Zeichnungsnummer	 A4 Index
erstellt von am A. Munishi am 02.10.2018	Artikel Bezeichnung 3002-2.5-16 RN SPT12	CUT-1071-35	-