

1 2 3 4 5 6

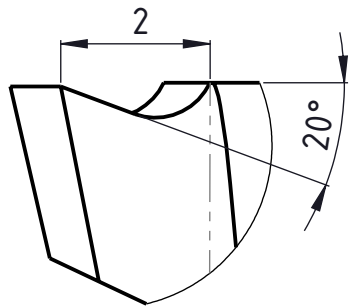

Z (10 : 1)

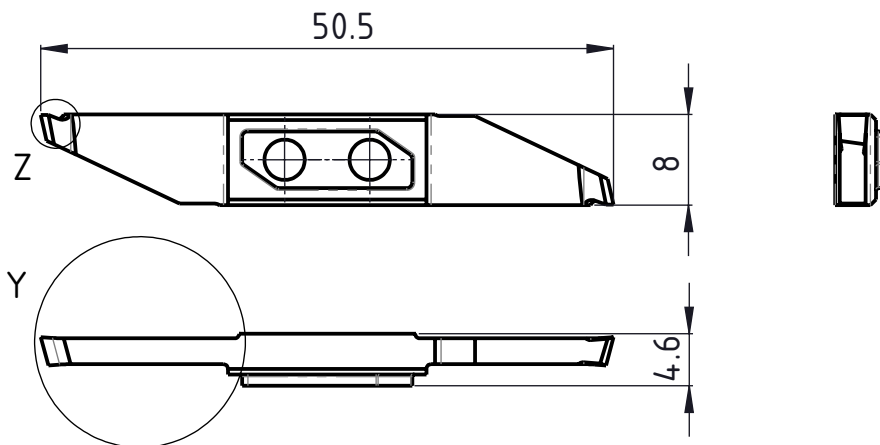

Y (10 : 1)

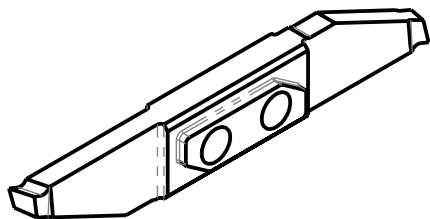
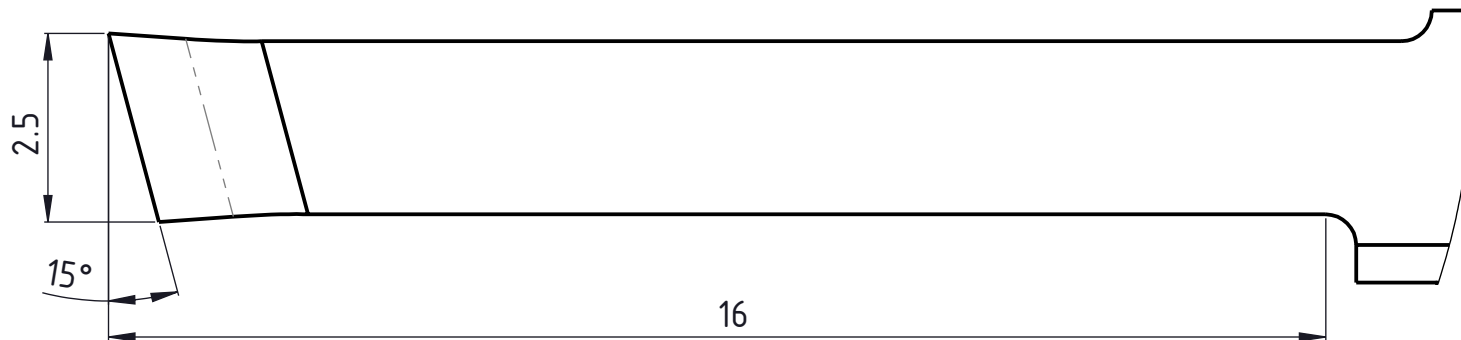

Linke Ausführung
Execution gauche
Left execution

DA-Kunde-V6



Freigegeben von am
E.Rahimi am 17.12.2018

erstellt von am
A. Munishi am 06.11.2018

Beschreibung
Multidec CUT-Wendeplatte

Artikel Bezeichnung
3002-2.5-16 LV SPT

Zeichnungsnummer

CUT-1085-10



Index
-