

1 2 3 4 5 6

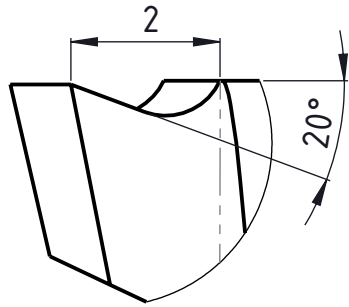

Z (10 : 1)

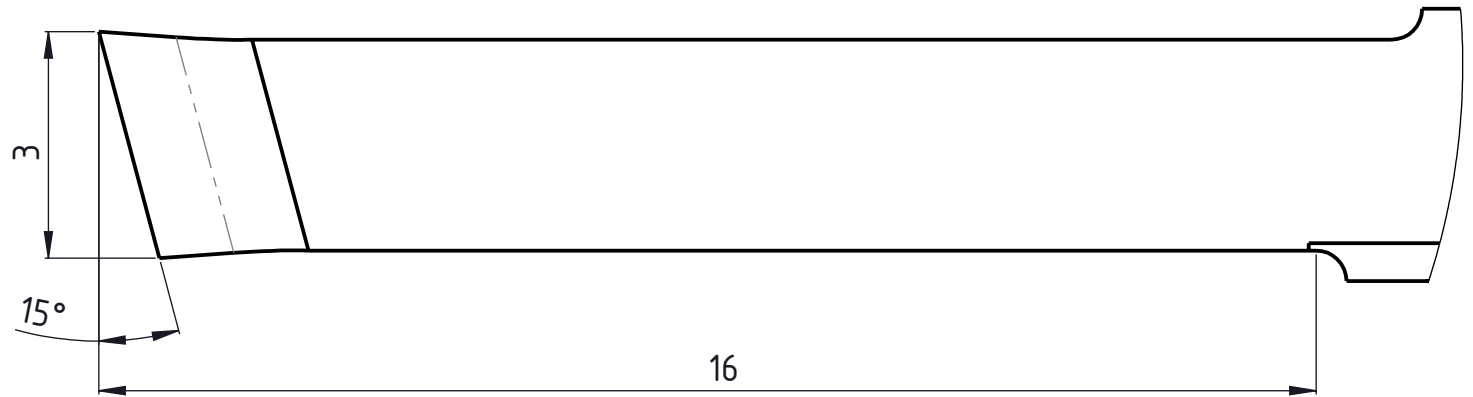
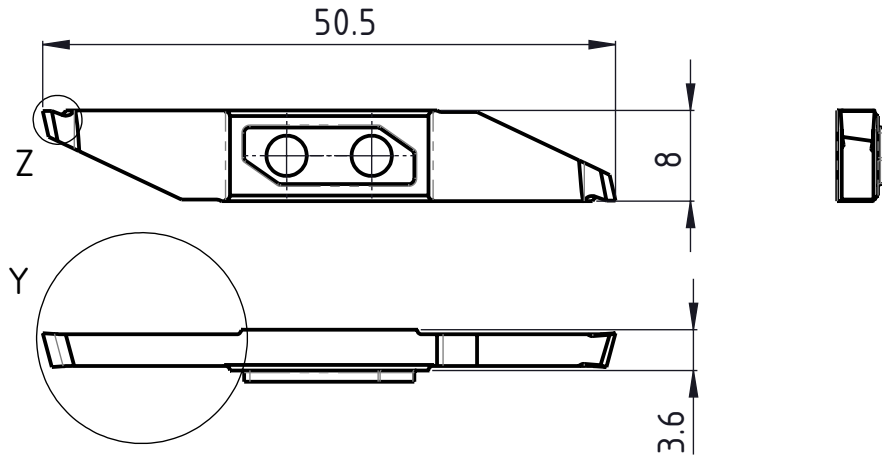

Y (10 : 1)

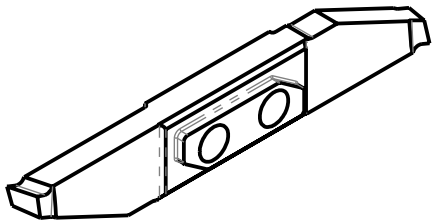

Linke Ausführung
Execution gauche
Left execution



Freigegeben von am
E.Rahimi am 13.02.2019

erstellt von am
A. Munishi am 06.11.2018

Beschreibung
Multidec CUT-Wendeplatte

Artikel Bezeichnung
3002-3.0-16 LV SPT

Zeichnungsnummer

CUT-1085-12



Index
-

A

B

C

D A4-Kunde-V6

A

B

C

D