

1 2 3 4 5 6

A

B

C

D

A4-Kunde V9

A

B

C

D

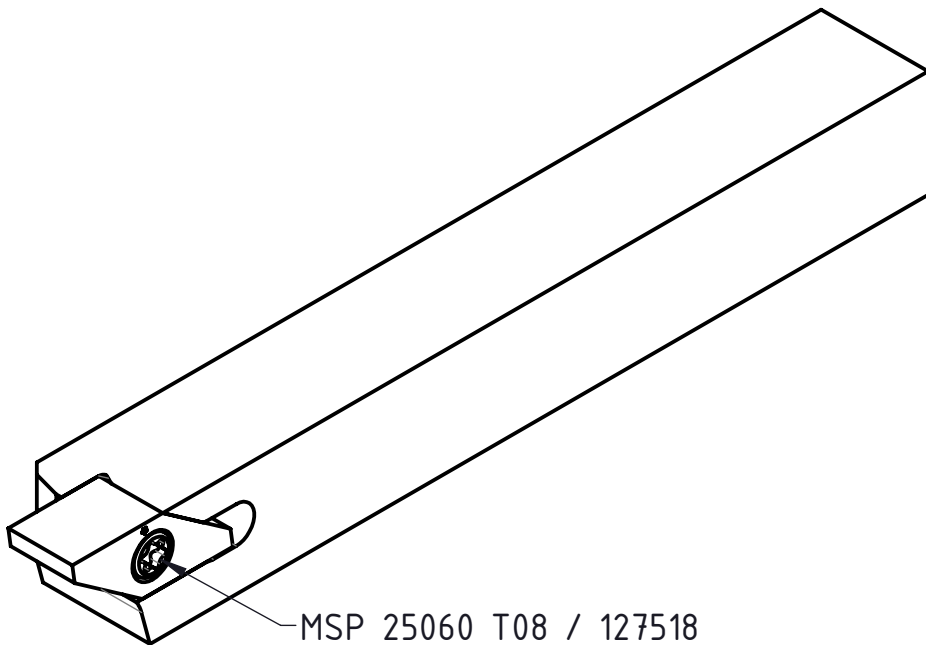

MSP 25060 T08 / 127518

Type 1600 right

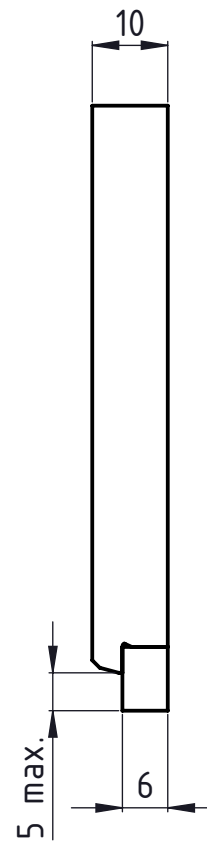
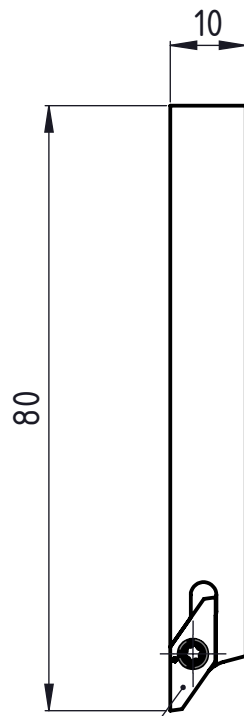

Rechte Ausführung  
Exécution droite  
Right execution

Beschreibung	Artikel Bezeichnung	Zeichnungsnummer	 	Index A
multidec CUT Halter	1600-10x80-6 R	CUT-128-6-23		

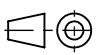
Beschreibung	Artikel Bezeichnung	Zeichnungsnummer	 	Index A
multidec CUT Halter	1600-10x80-6 R	CUT-128-6-23		

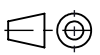
Beschreibung	Artikel Bezeichnung	Zeichnungsnummer	 	Index A
multidec CUT Halter	1600-10x80-6 R	CUT-128-6-23		

Beschreibung	Artikel Bezeichnung	Zeichnungsnummer	 	Index A
multidec CUT Halter	1600-10x80-6 R	CUT-128-6-23		