

1 2 3 4 5 6

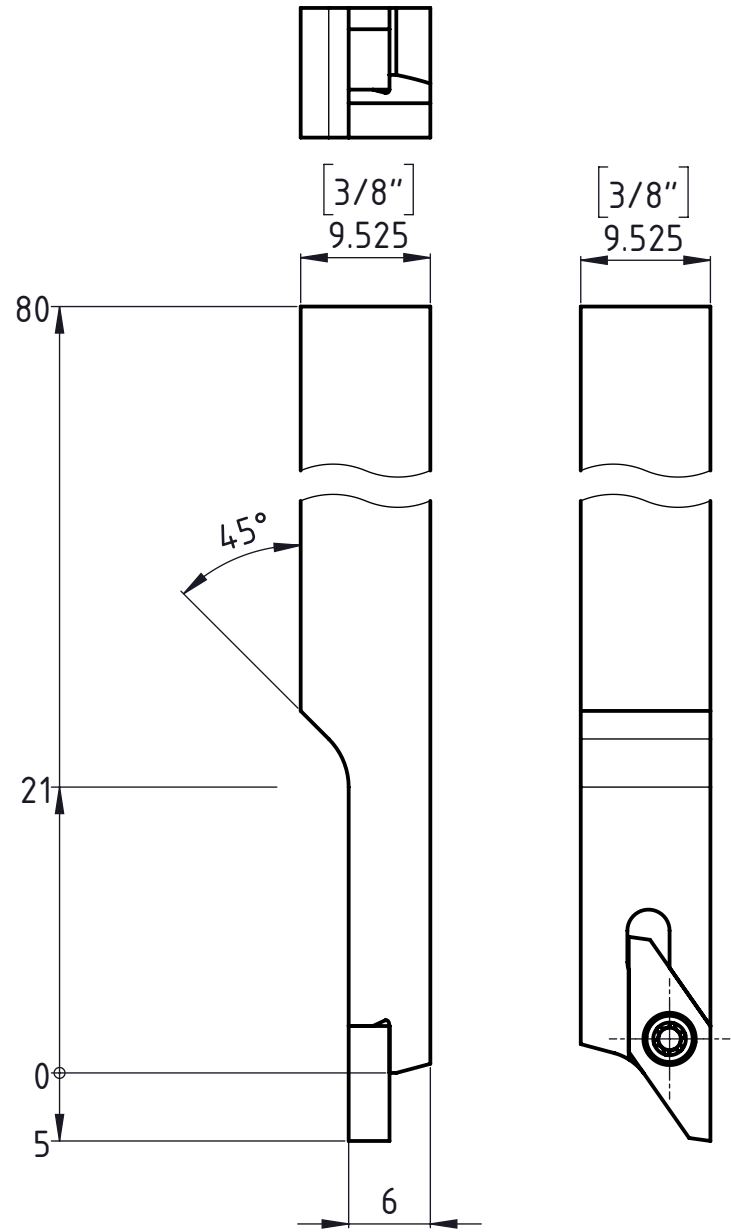
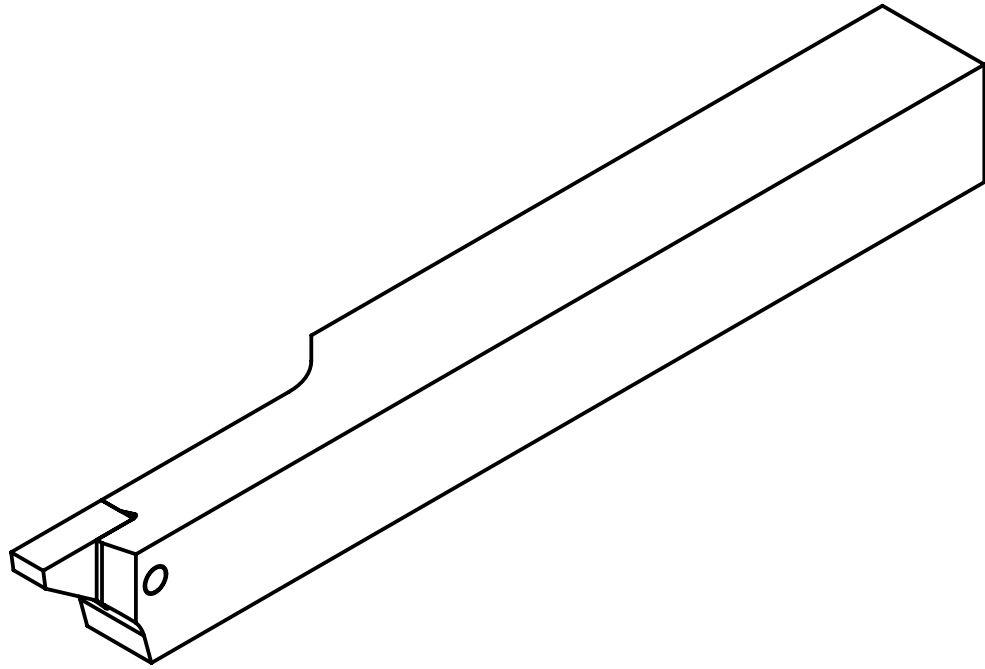

A

B

C

D

A

B

C

D

Rechte Ausführung
 Execution droite
 Right execution



Freigegeben von am
 T.Weilenmann am 14.02.2018
 erstellt von am
 T.Weilenmann am 14.02.2018

Beschreibung
 Multidec Cut Halter
 Artikel Bezeichnung
 1600-3/8"x80LA

Zeichnungsnummer
 CUT-129-32

