

1 2 3 4 5 6

A

B

C

D

A

B

C

D

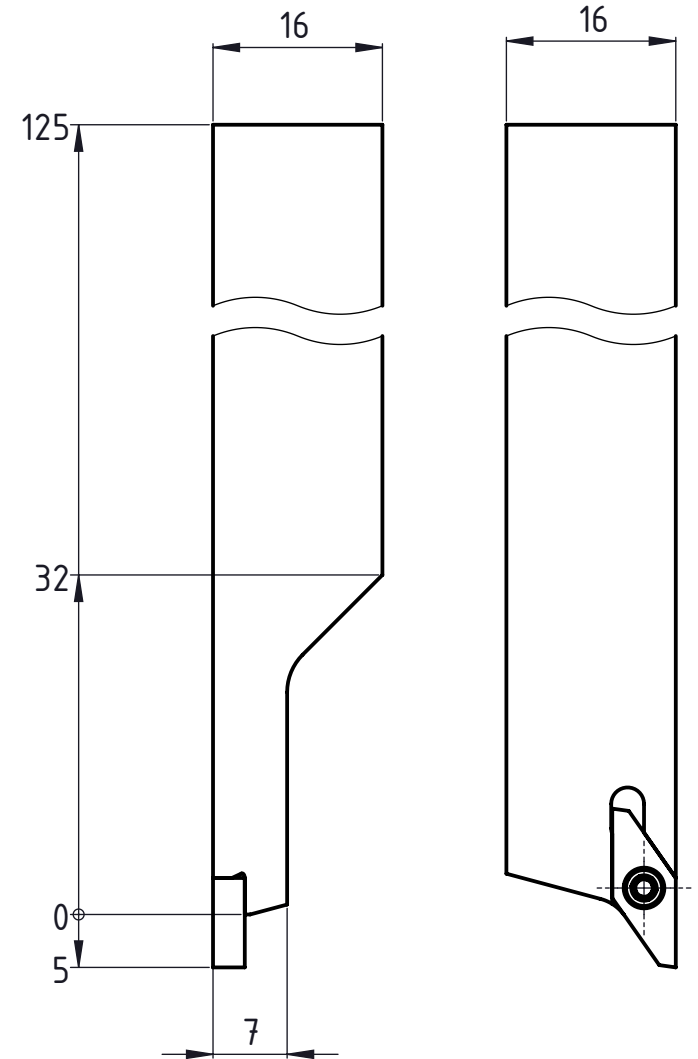
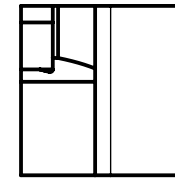
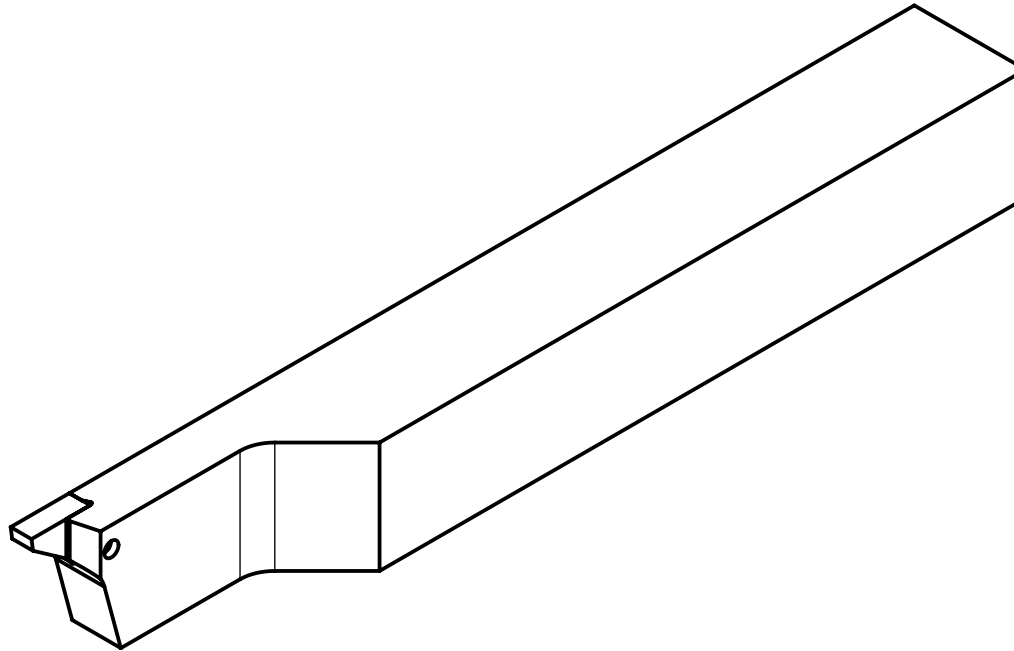

Rechte Ausführung
 Execution droite
 Right execution



Freigegeben von am
 T.Weilenmann am 26.02.2018
 erstellt von am
 T.Weilenmann am 23.02.2018

Beschreibung
 Multidec-Cut Halter
 Artikel Bezeichnung
 1600-16x125 LAV

Zeichnungsnummer
 CUT-130-20

