

4

3

2

1

F

F

E

E

D

D

C

C

B

B

A

A

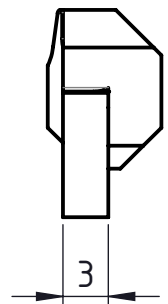
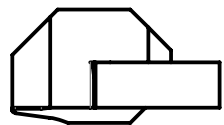

Typ 1600 left

10,5

7,5

6

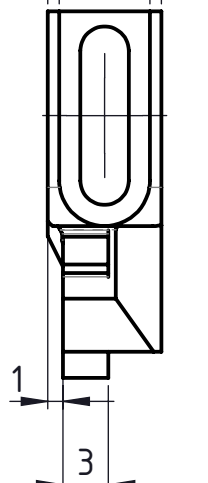
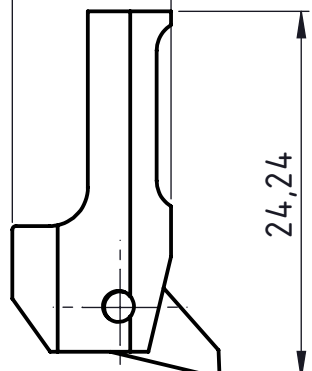
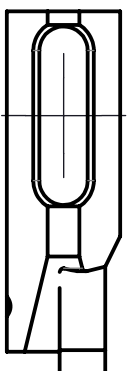
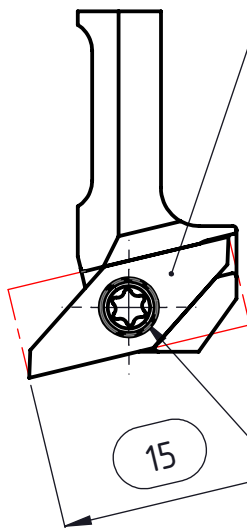

15

Nm1,2

24,24

1

3

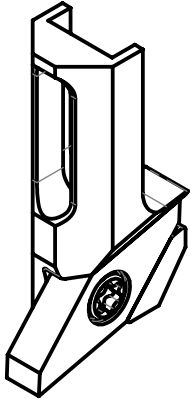

A4-Hoch Kunde-V8

Artikel Bezeichnung

ESCO 303-2125-1 CUT 1600 L

Beschreibung

multidec-ESCOMATIC Halter

Format

A4

Zeichnungsnummer

CUT-1451-3-1



Index

-

