

1 2 3 4 5 6

A

A

B

B

C

C

D

D

A4-Kunde V7

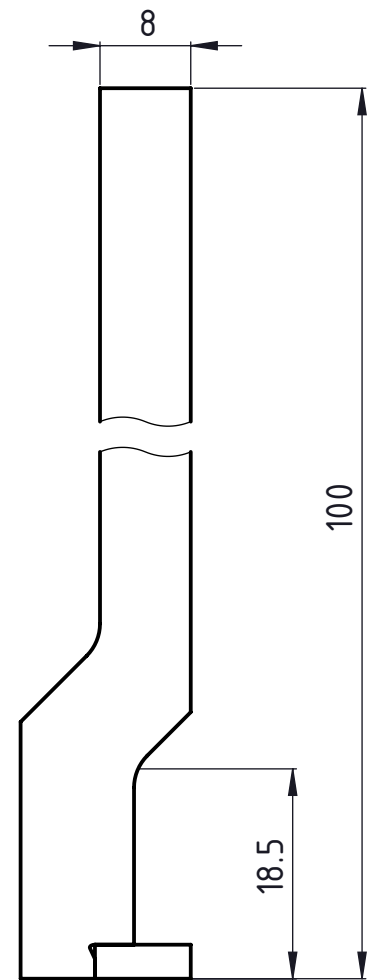
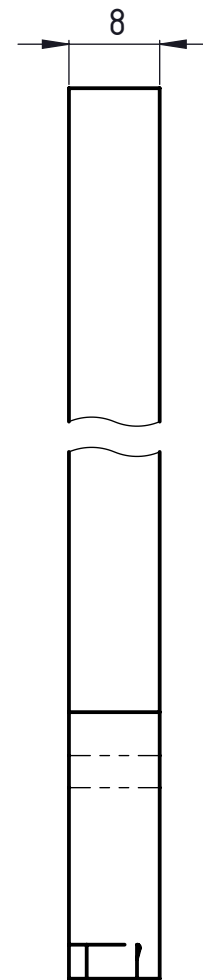
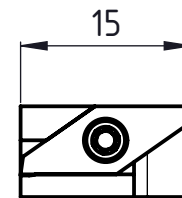
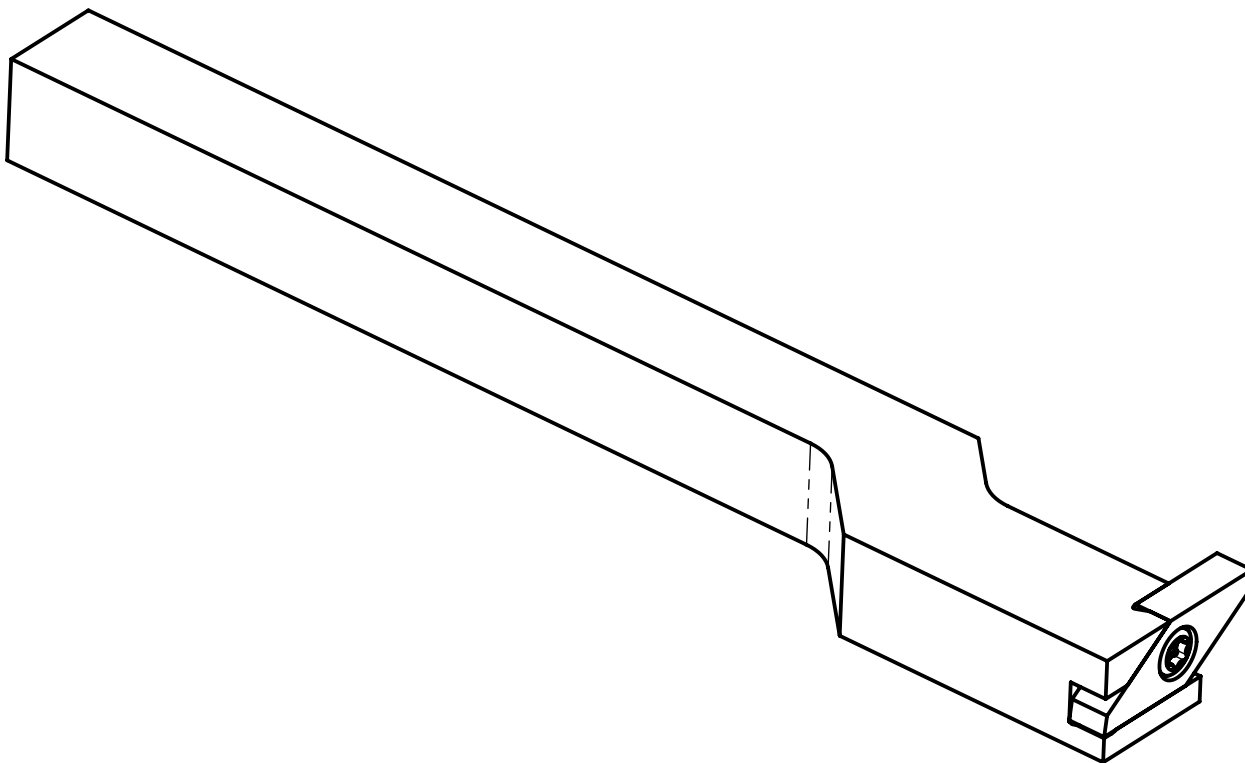

Freigegeben von am

T.Weilenmann am 05.06.2019

erstellt von am

A.Munishi am 03.06.2019

Beschreibung

multidec Cut-Halter

Artikel Bezeichnung

1600-08x100 90 ST RA

UTILIS[®]

Tooling for High Technology

Zeichnungsnummer

CUT-153-02-11



A4

Index

B