

1

2

3

4

5

6

A

A

B

B

C

C

D

D

A4-Kunde V7

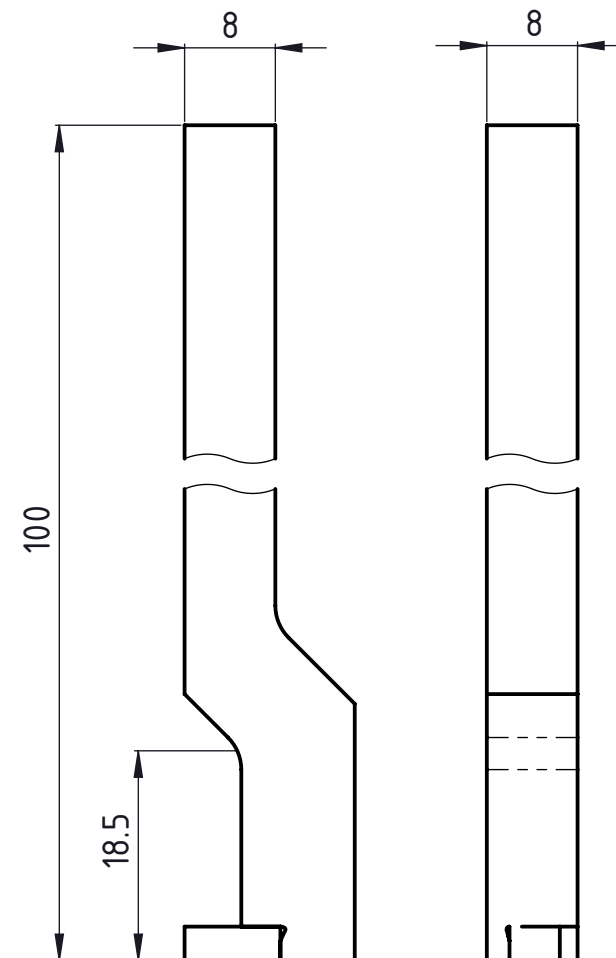
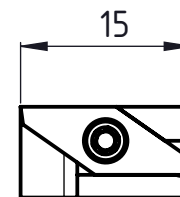
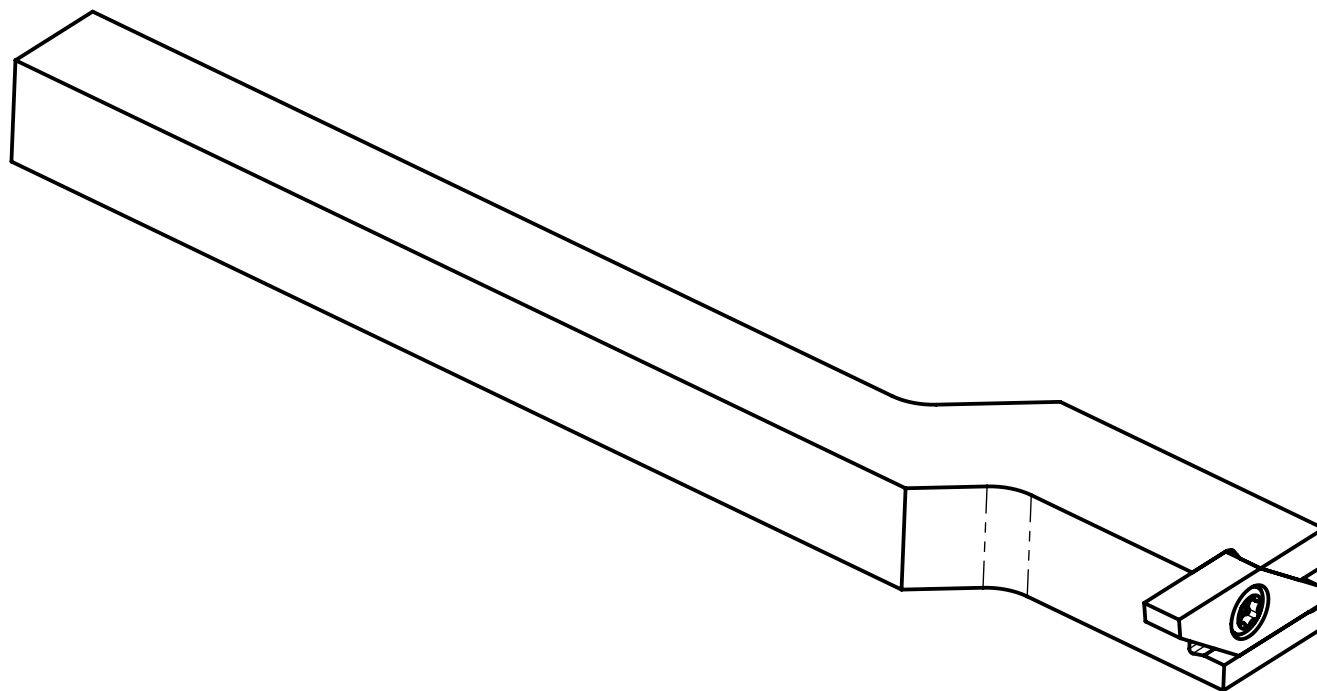

Freigegeben von am

T.Weilenmann am 05.06.2019

erstellt von am

A.Munishi am 03.06.2019

Beschreibung

multidec Cut-Halter

Artikel Bezeichnung

1600-08x100 90 ST LA

UTILIS[®]

Tooling for High Technology

Zeichnungsnummer

CUT-153-02-12

A4
Index
B