

1 2 3 4 5 6

A

A

B

B

C

C

D

D

A4-Kunde V7

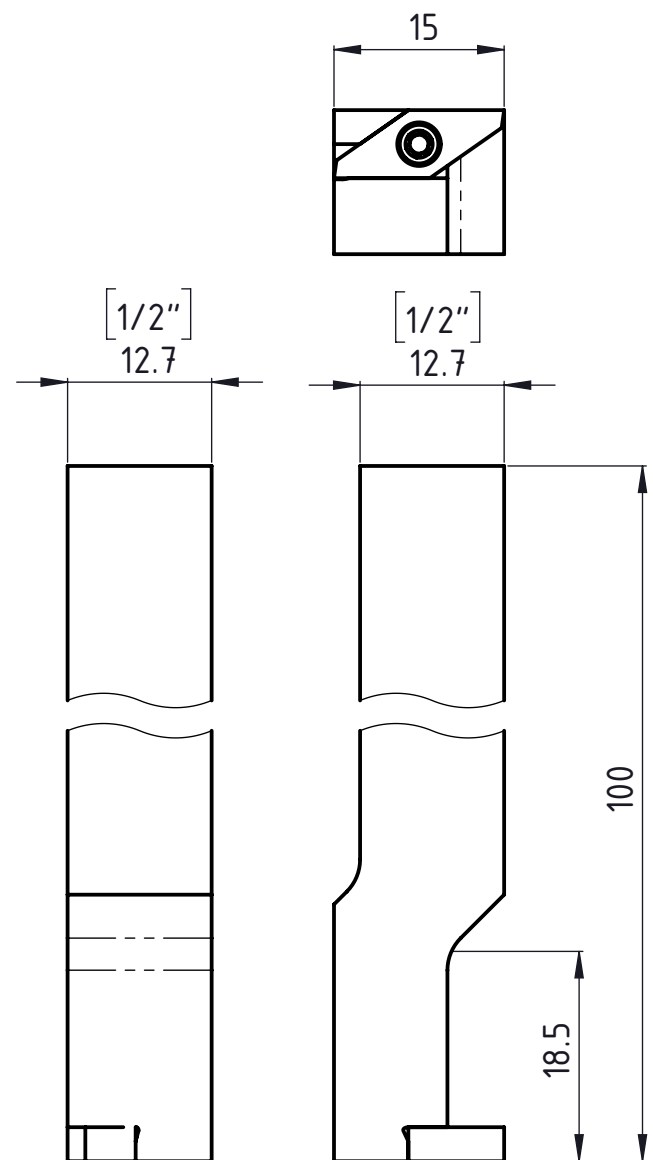
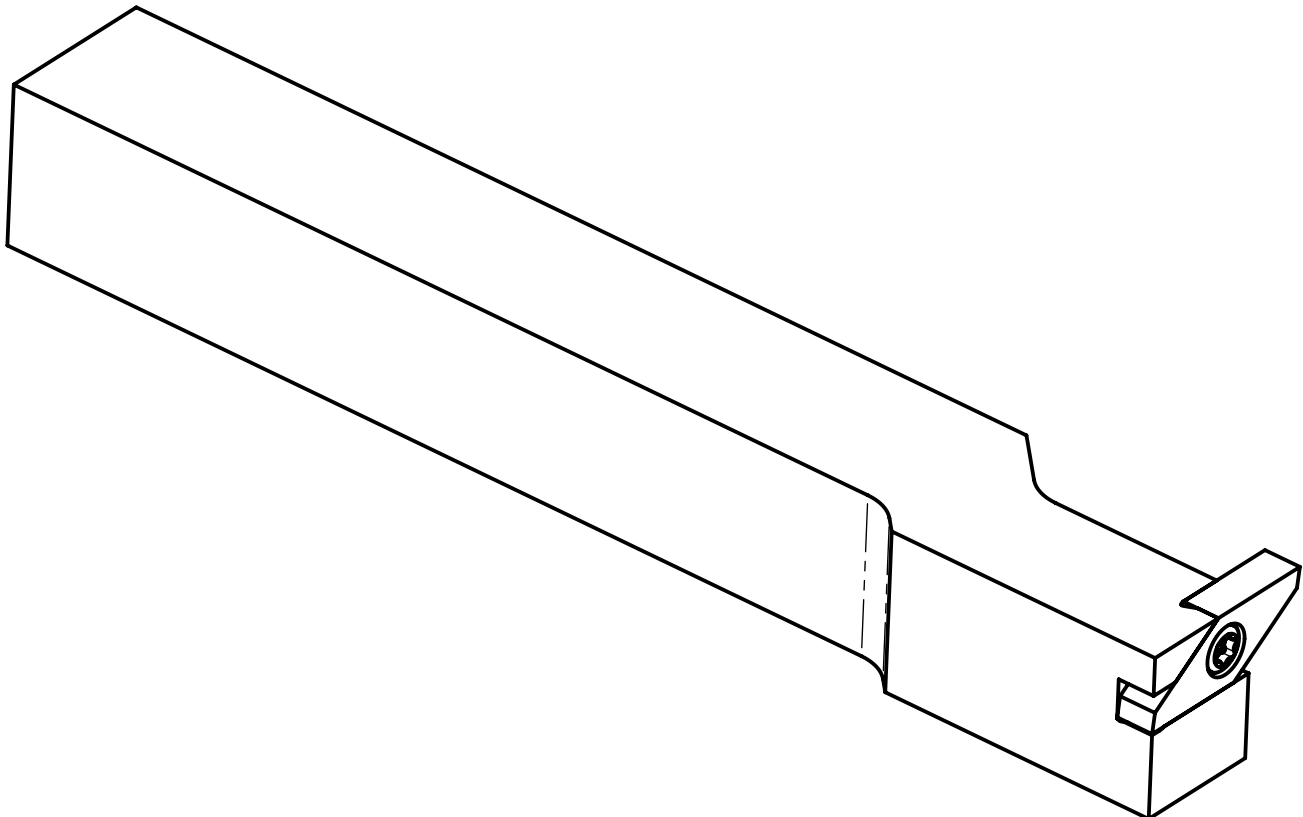

Freigegeben von am

T.Weilenmann am 06.06.2019

erstellt von am

A.Munishi am 03.06.2019

Beschreibung

multidec Cut-Halter

Artikel Bezeichnung

1600-1/2"x100 90 ST RA

UTILIS[®]

Tooling for High Technology

Zeichnungsnummer

CUT-153-02-23



A4

Index

B