

1 2 3 4 5 6

A

B

C

D

A

B

C

D

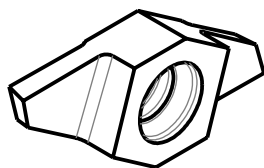
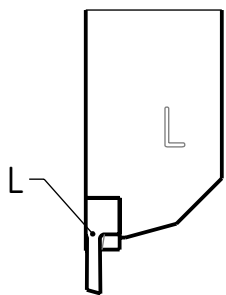
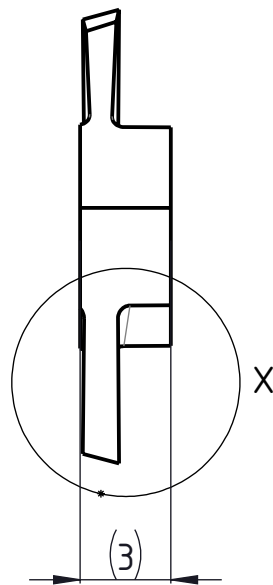
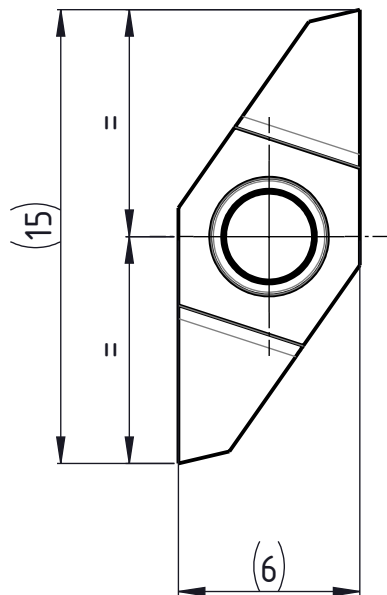

X (10 : 1)

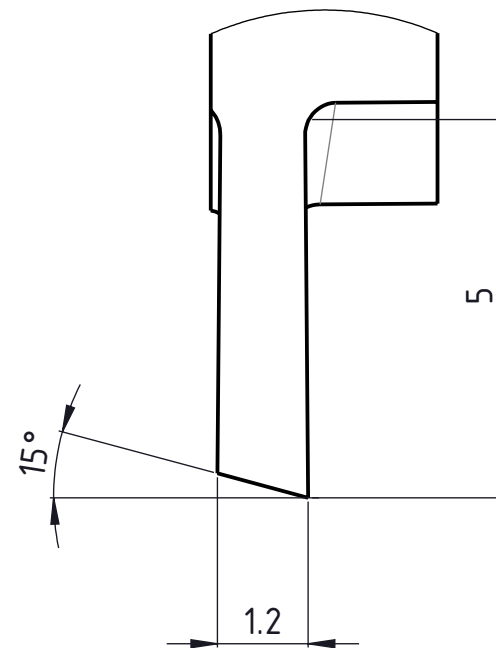

Linke Ausführung
Execution gauche
Left execution

Beschreibung
multidec CUT-Wendeplatte

Artikel Bezeichnung
1602-1.2-5 L

Zeichnungsnummer
CUT-1602-01-08

UTILIS[®]
Tooling for High Technology



Index
-