

A

B

C

D

A

B

C

D

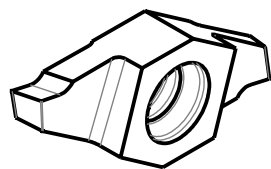
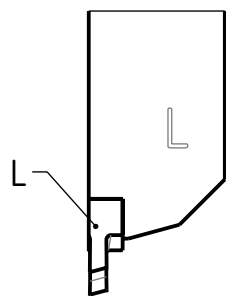
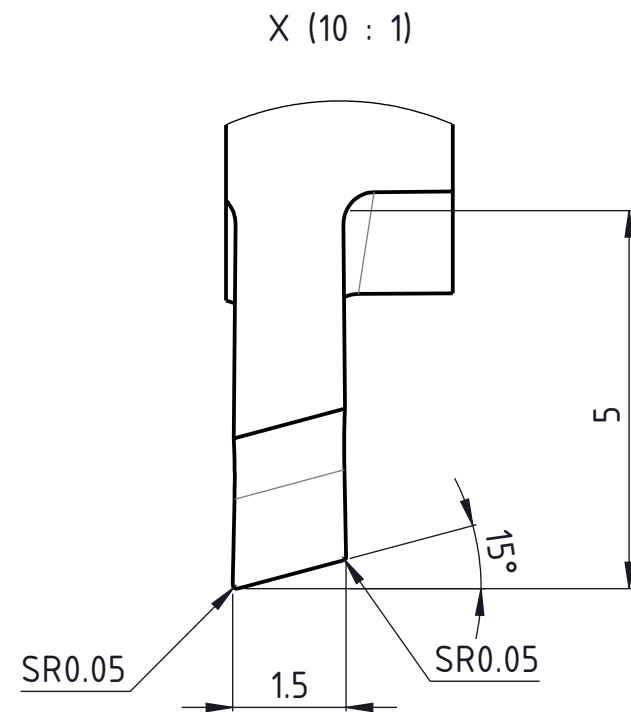
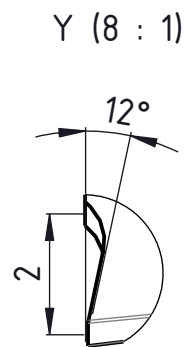
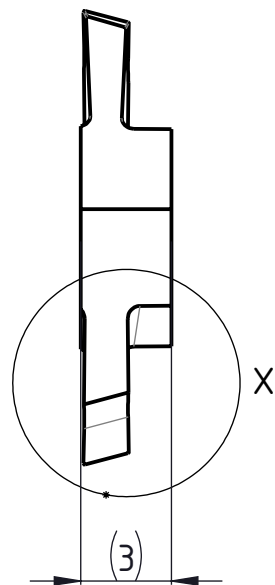
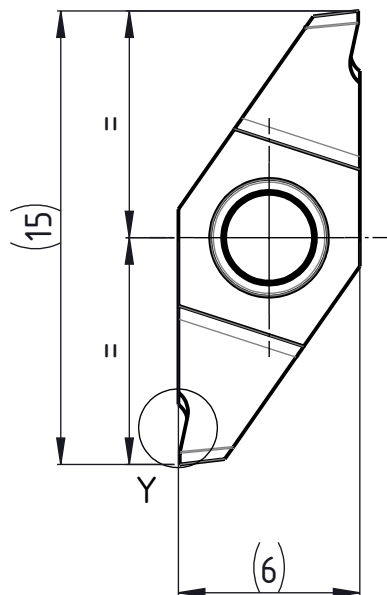

Linke Ausführung
 Execution gauche
 Left execution

Beschreibung
multidec CUT-Wendeplatte

Artikel Bezeichnung
1602-1.5-5 LV SPT12

Zeichnungsnummer
CUT-1602-01-106

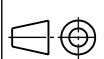

Index
 -