

1 2 3 4 5 6

A

B

C

D

A

B

C

D

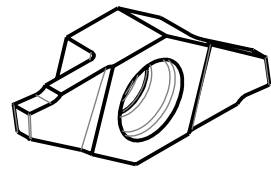
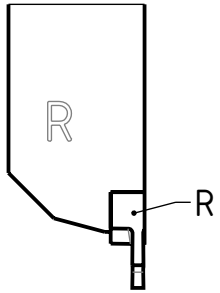
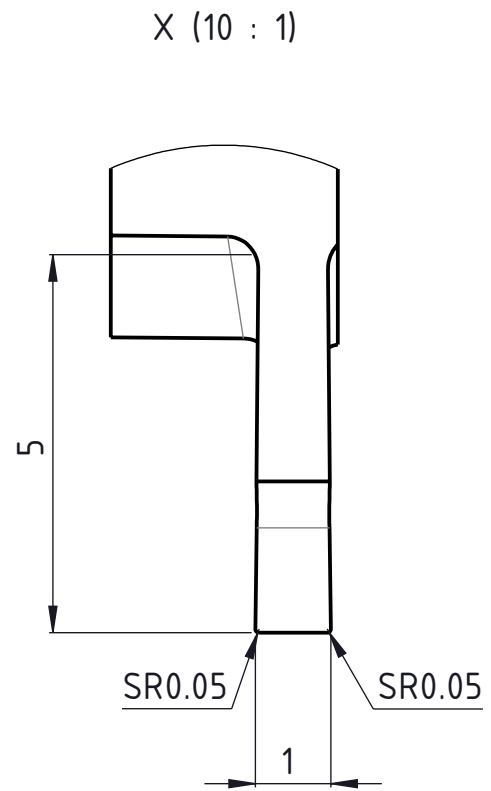
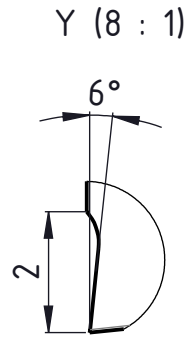
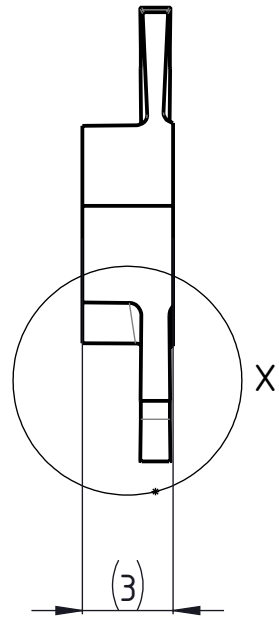
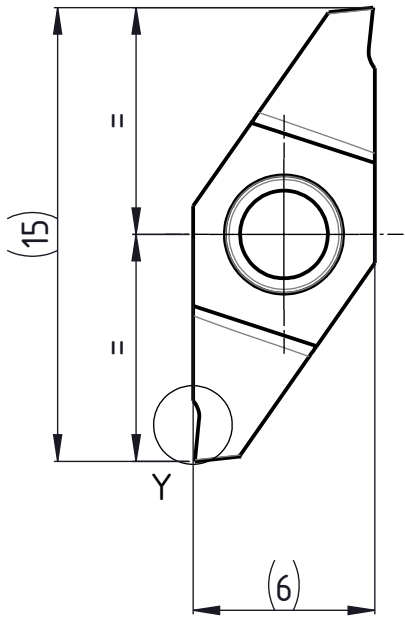

Rechte Ausführung
 Execution droite
 Right execution

Beschreibung
multidec CUT-Wendeplatte

Artikel Bezeichnung
1602-1.0-5 RN SPT06

Zeichnungsnummer
CUT-1602-01-113

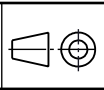

Index
 -