

1 2 3 4 5 6

A

B

C

D

A



B

C

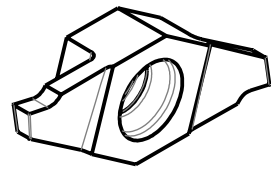
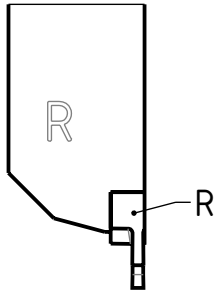
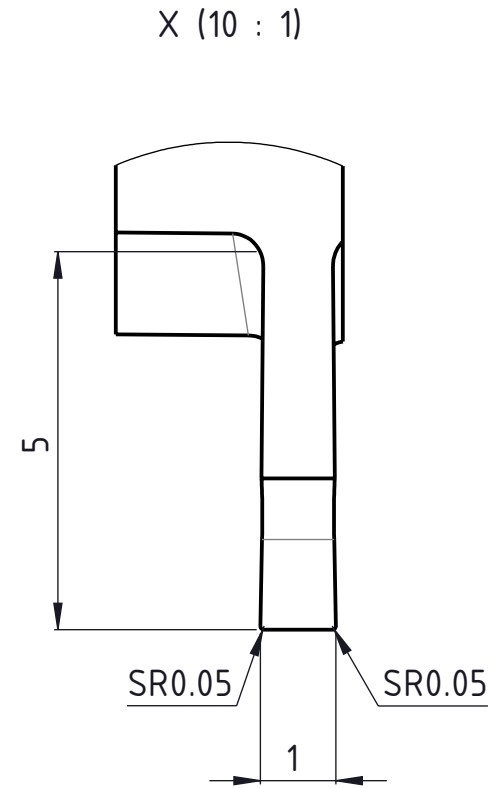
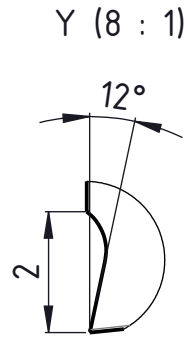
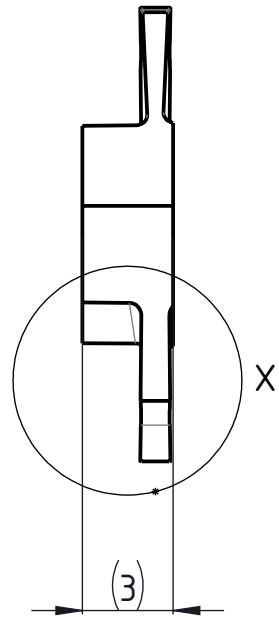
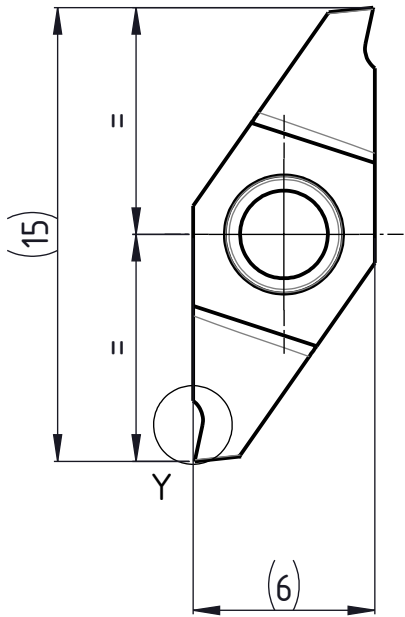
D



Rechte Ausführung  
 Execution droite  
 Right execution

Beschreibung <b>multidec CUT-Wendeplatte</b>	Artikel Bezeichnung <b>1602-1.0-5 RN SPT12</b>	Zeichnungsnummer <b>CUT-1602-01-115</b>	 <small>Tooling for High Technology</small>	 Index -
---	---	--	---	--