

1 2 3 4 5 6

A

A

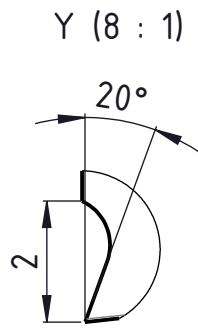
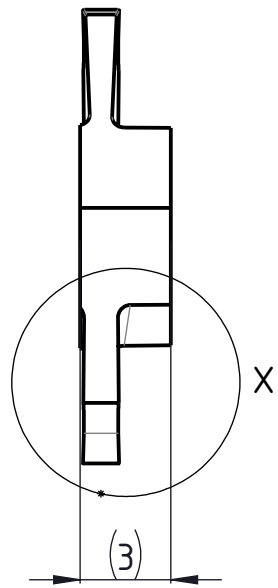
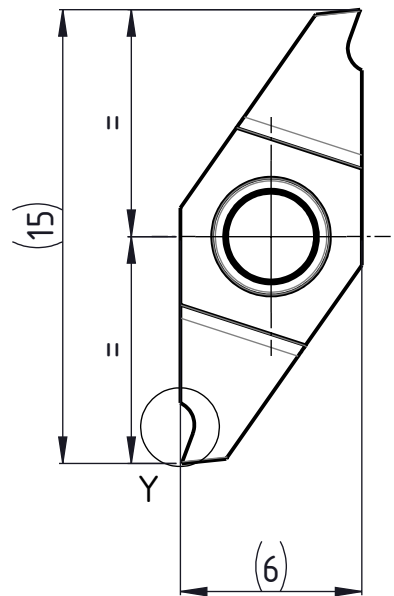

X (10 : 1)

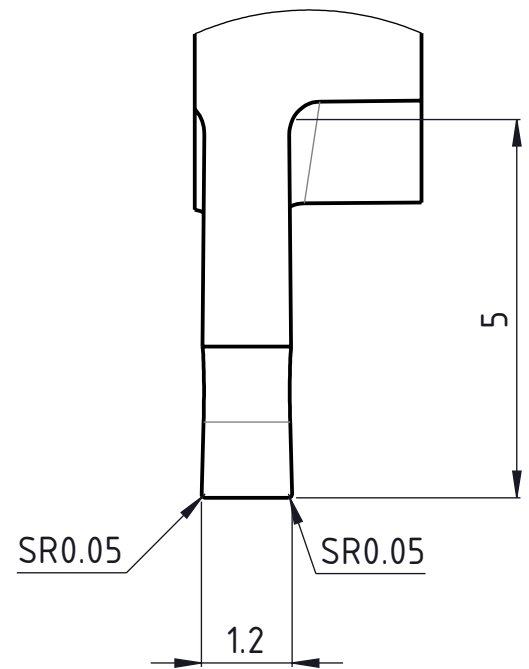

B

B

C

C

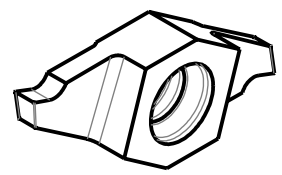
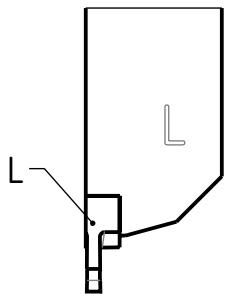

D

D

Linke Ausführung  
Execution gauche  
Left execution

Beschreibung

multidec CUT-Wendeplatte

Artikel Bezeichnung

1602-1.2-5 LN SPT

Zeichnungsnummer

CUT-1602-01-118

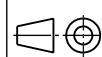

Index  
-