

1 2 3 4 5 6

A

B

C

D

A

B

C

D

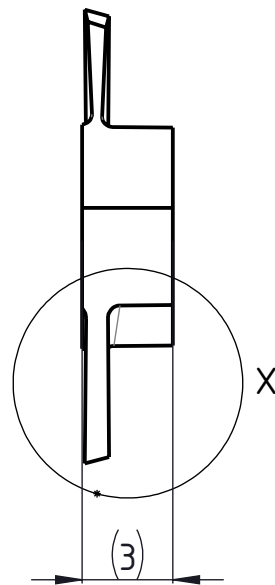
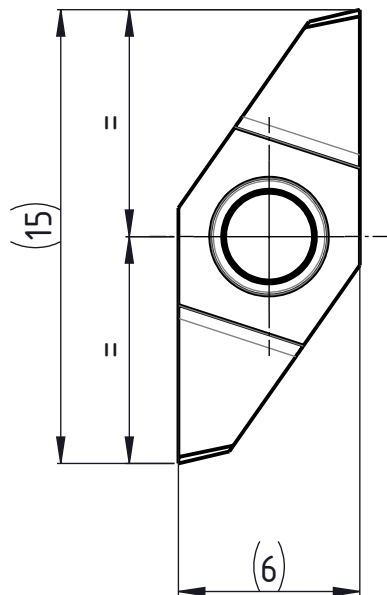

X (10 : 1)

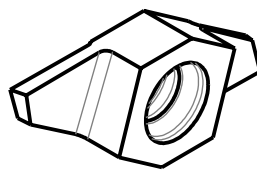
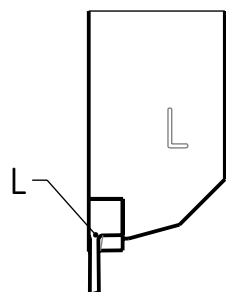
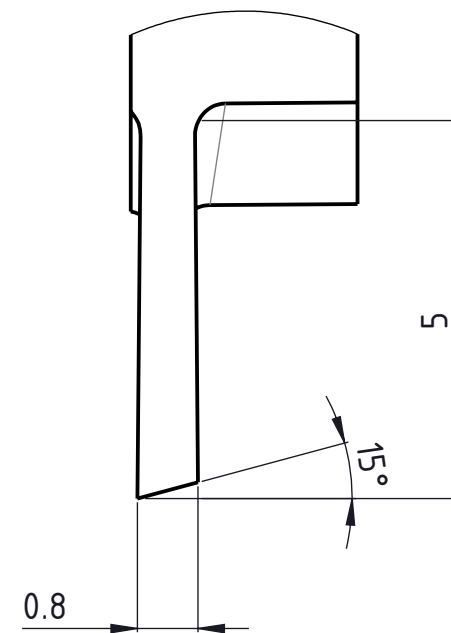

Linke Ausführung
Execution gauche
Left execution

Beschreibung
multidec CUT-Wendeplatte

Artikel Bezeichnung
1602-0.8-5 LV

Zeichnungsnummer
CUT-1602-01-20

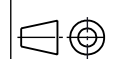

Index
-