

1 2 3 4 5 6

A

A

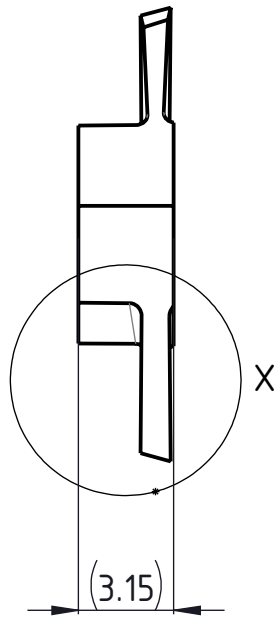
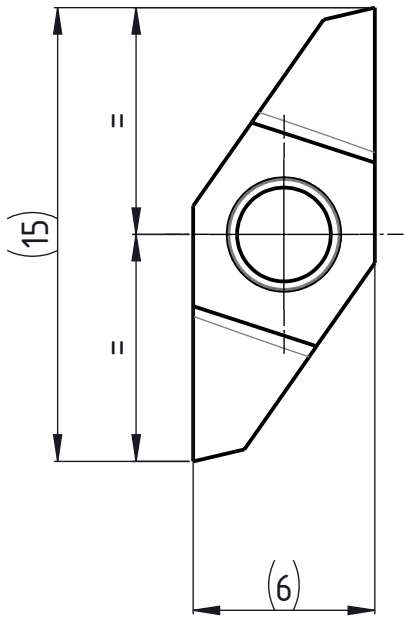

X (10 : 1)

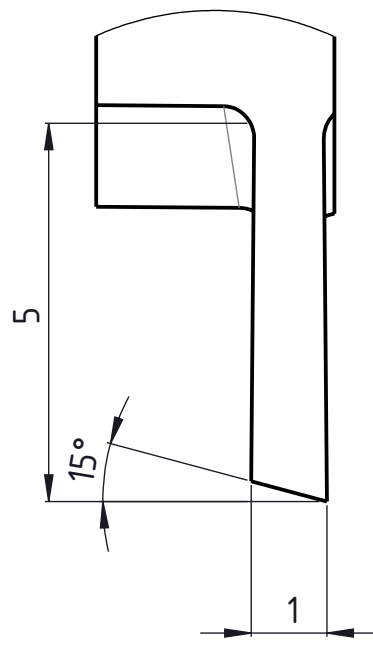

B

B

C

C

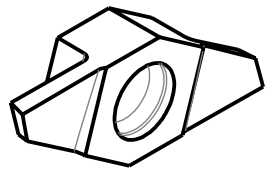
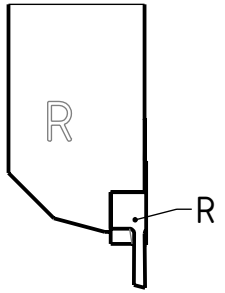

D

D

Rechte Ausführung
Execution droite
Right execution

Beschreibung

multidec CUT-Wendeplatte

Artikel Bezeichnung

1602 B-1.0-5 RV

Zeichnungsnummer

CUT-1602-01-51

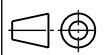

Index
A