

1 2 3 4 5 6

A

B

C

D

A

B

C

D

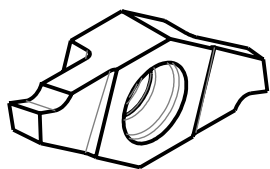
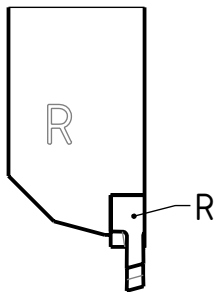
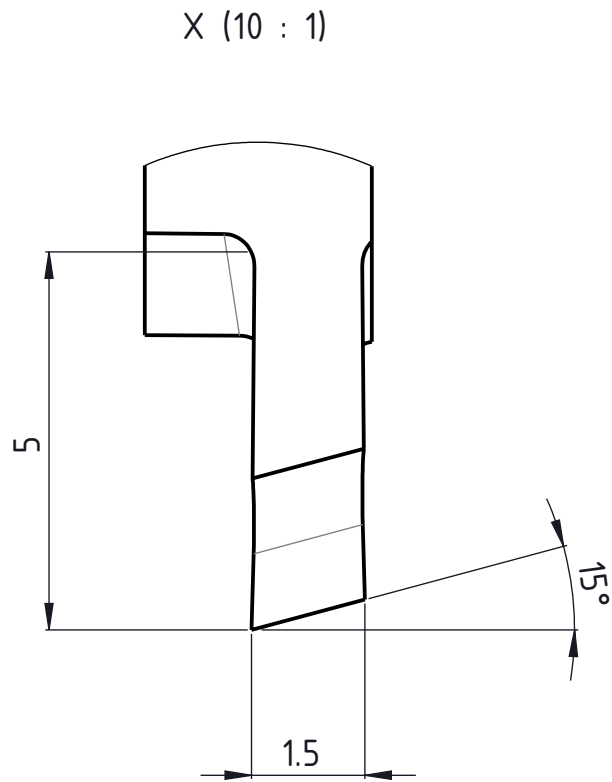
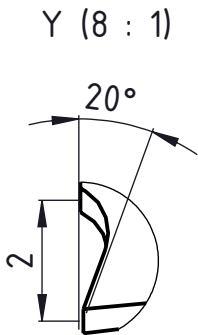
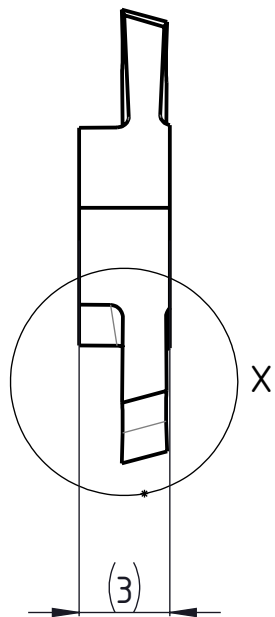
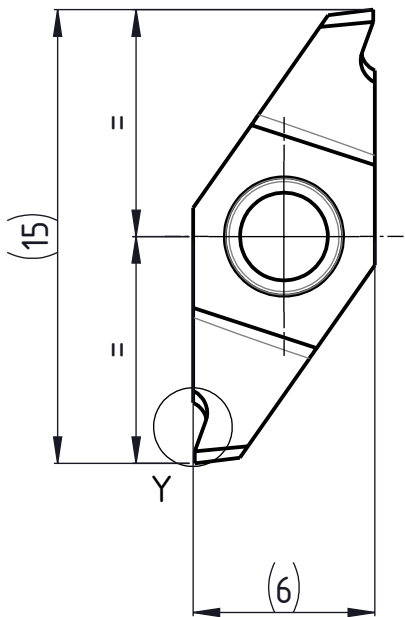

Rechte Ausführung  
 Execution droite  
 Right execution

Beschreibung  
**multidec CUT-Wendeplatte**

Artikel Bezeichnung  
**1602-1.5-5 R SPT**

Zeichnungsnummer  
**CUT-1602-01-85**

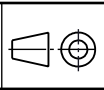

Index  
 -