

1 2 3 4 5 6

A

B

C

D

A

B

C

D

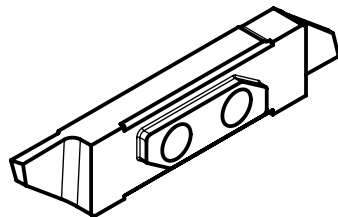
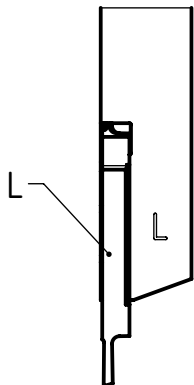
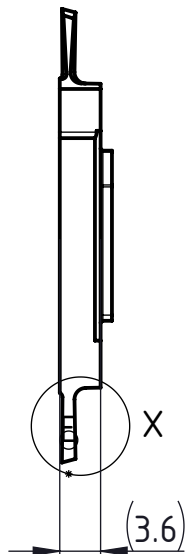
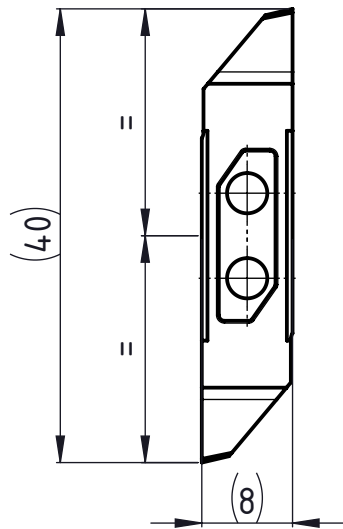

X (10 : 1)

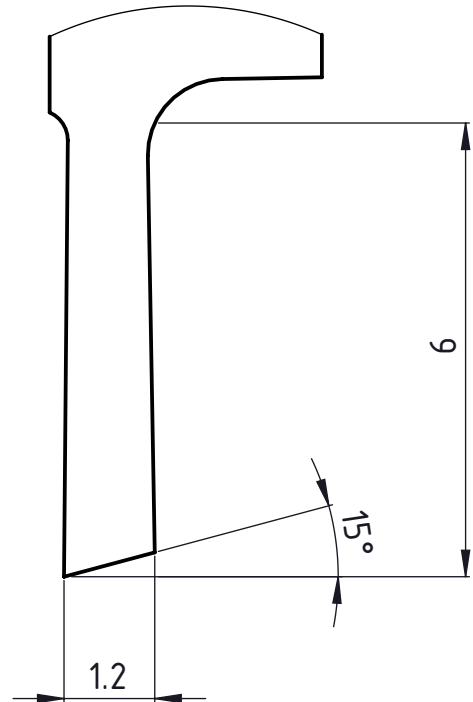

Linke Ausführung
Execution gauche
Left execution

Beschreibung

multidec CUT-Wendeplatte

Artikel Bezeichnung

3002-1.2-6 LV

Zeichnungsnummer

CUT-3002-01-22

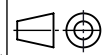

Index
A