

1 2 3 4 5 6

A

A

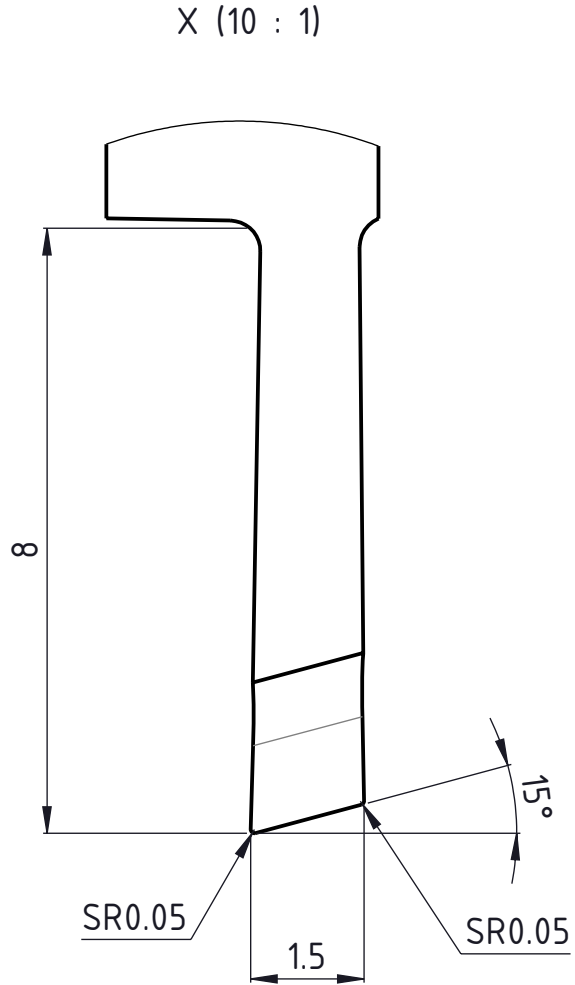
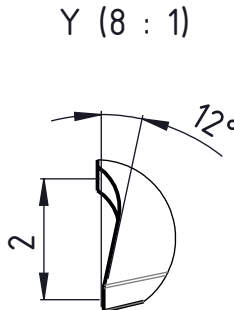
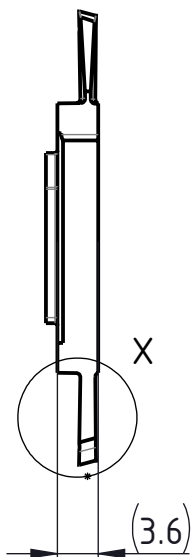
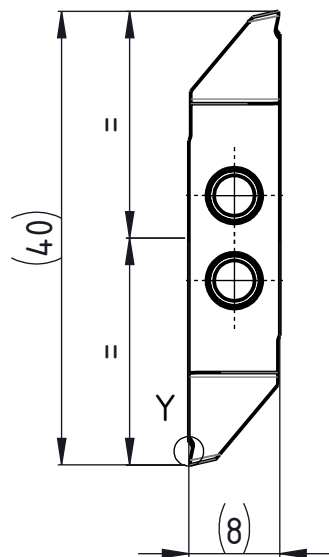

B

B

C

C

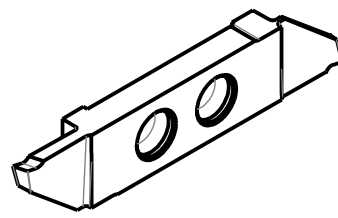
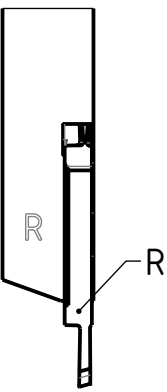

D

D

Rechte Ausführung  
 Execution droite  
 Right execution

Beschreibung  
**multidec CUT-Wendeplatte**

Artikel Bezeichnung  
**3002-1.5-8 R SPT12**

Zeichnungsnummer  
**CUT-3002-01-53**

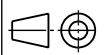

Index  
 -