

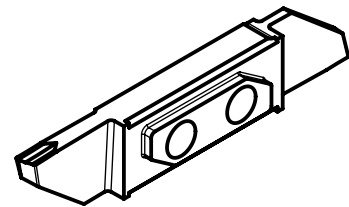

X (10 : 1)

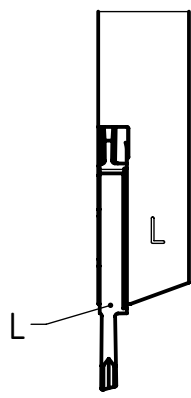
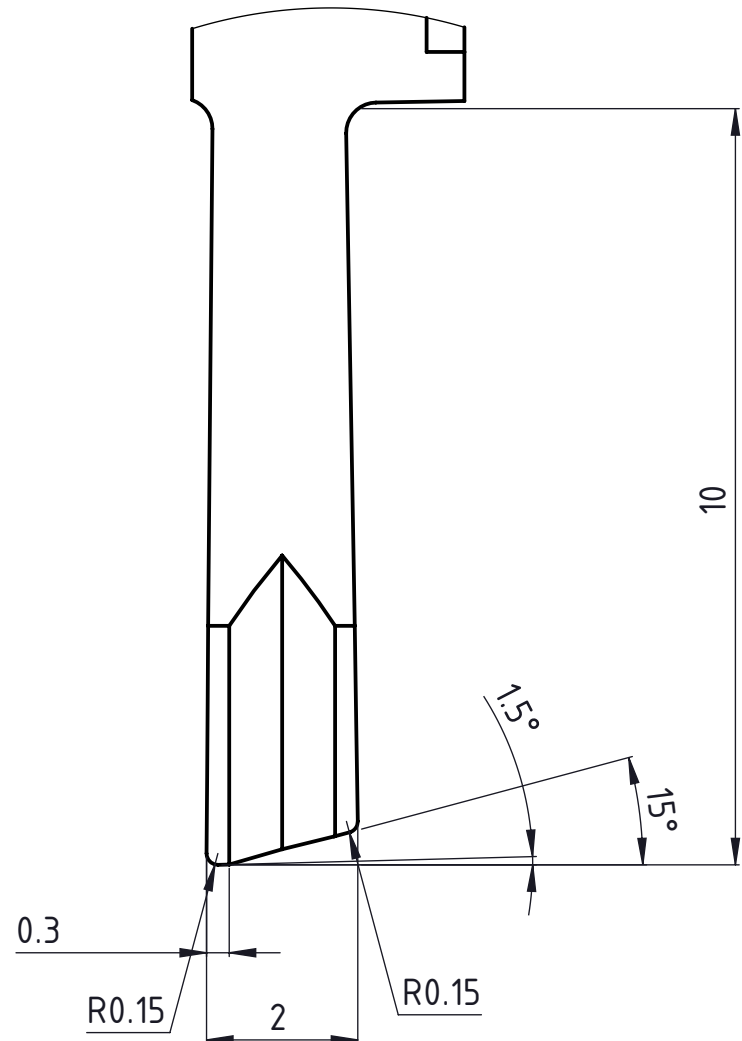
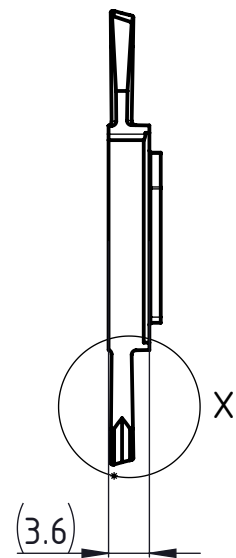
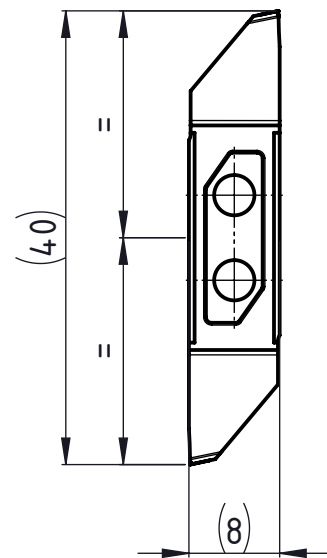
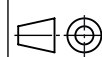

Linke Ausführung
 Execution gauche
 Left execution

Beschreibung multidec CUT-Wendeplatte	Artikel Bezeichnung 3002-2.0-10 LV SC TOP 015	Zeichnungsnummer CUT-3002-02-20	  Index -
---	---	---	--