

1 2 3 4 5 6

A

B

C

D

A

B

C

D

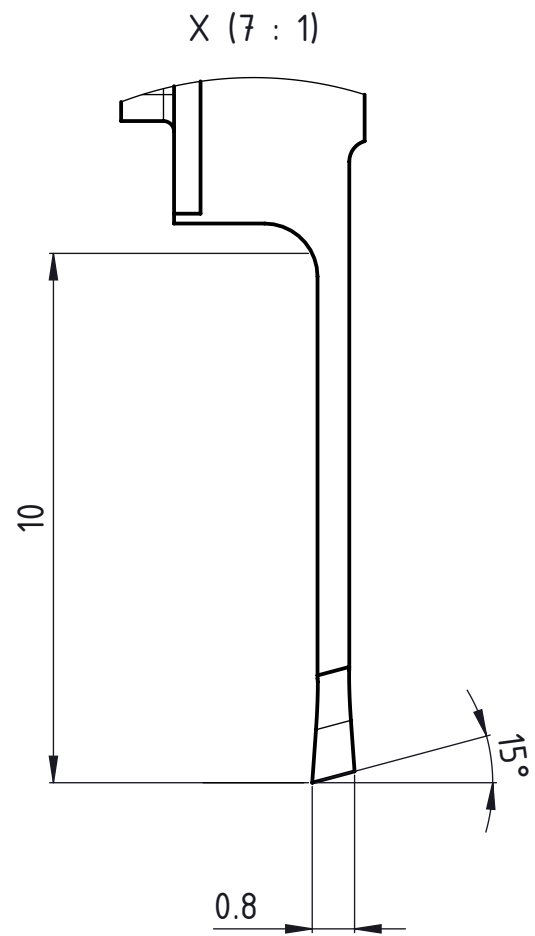
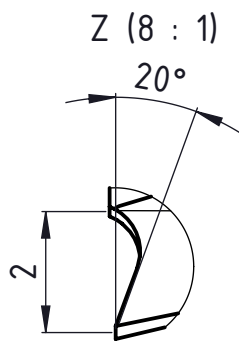
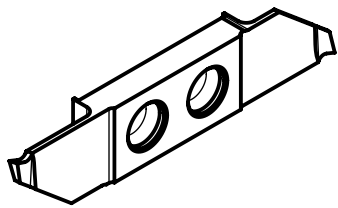
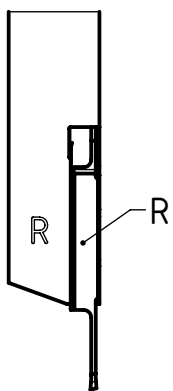
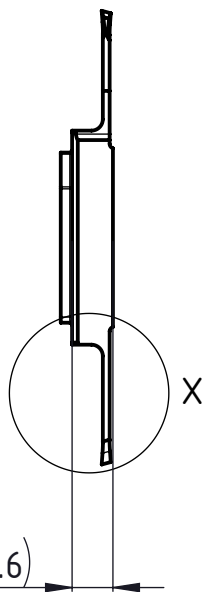
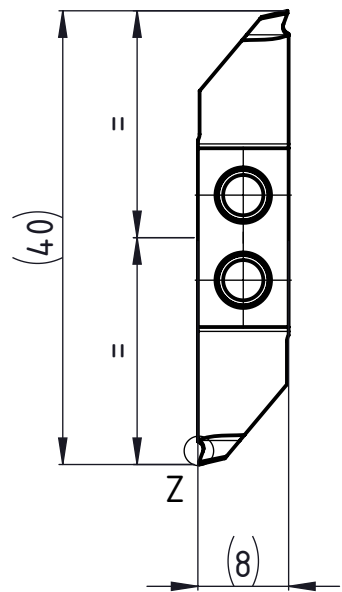

Rechte Ausführung
 Execution droite
 Right execution

Beschreibung

multidec CUT-Wendeplatte

Artikel Bezeichnung

3002-0.8-10 R SPT

Zeichnungsnummer

CUT-3002-05-33

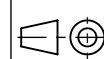

Index
 A