

1 2 3 4 5 6

A

B

C

D

A

B

C

D

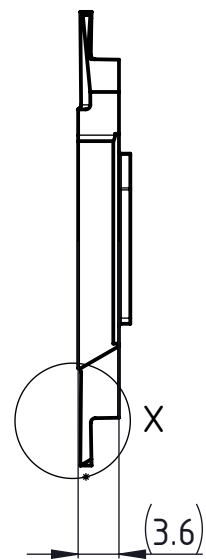
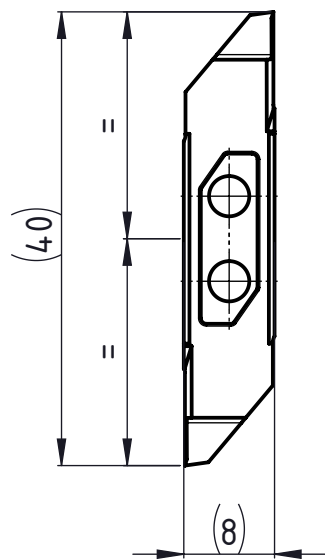

A-A

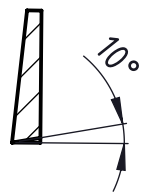

X (10 : 1)

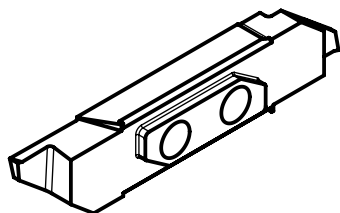
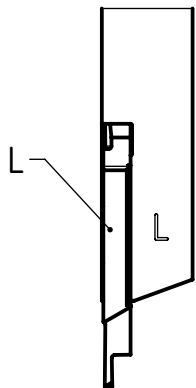
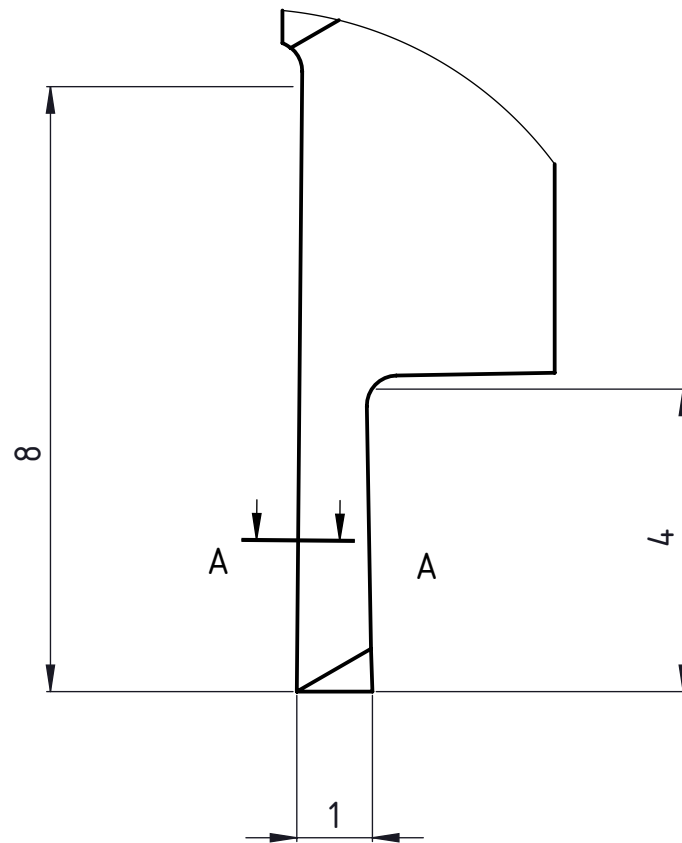

Linke Ausführung
 Execution gauche
 Left execution

Beschreibung

multidec CUT-Wendeplatte

Artikel Bezeichnung

3005-1.0-8 L CP

Zeichnungsnummer

CUT-3005-01-04

UTILIS[®]
 Tooling for High Technology

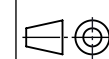

Index
 -