

1 2 3 4 5 6

A

B

C

D

A

B

C

D

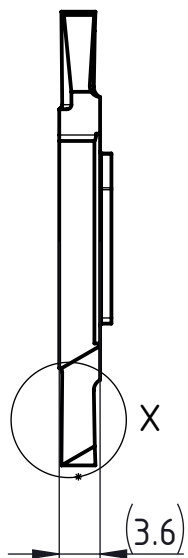
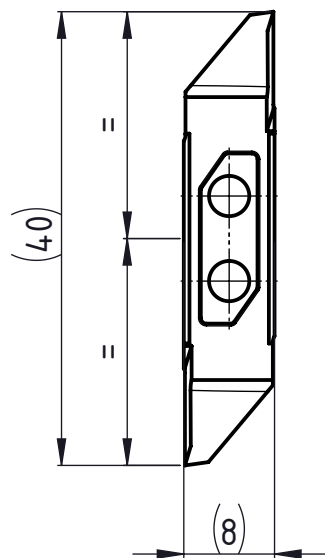

A-A

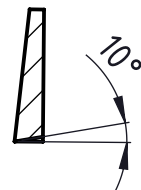

X (10 : 1)

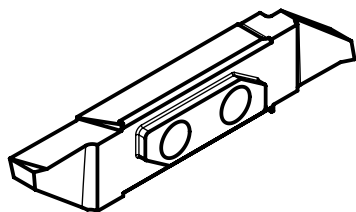
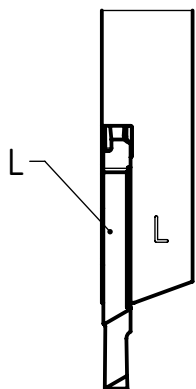
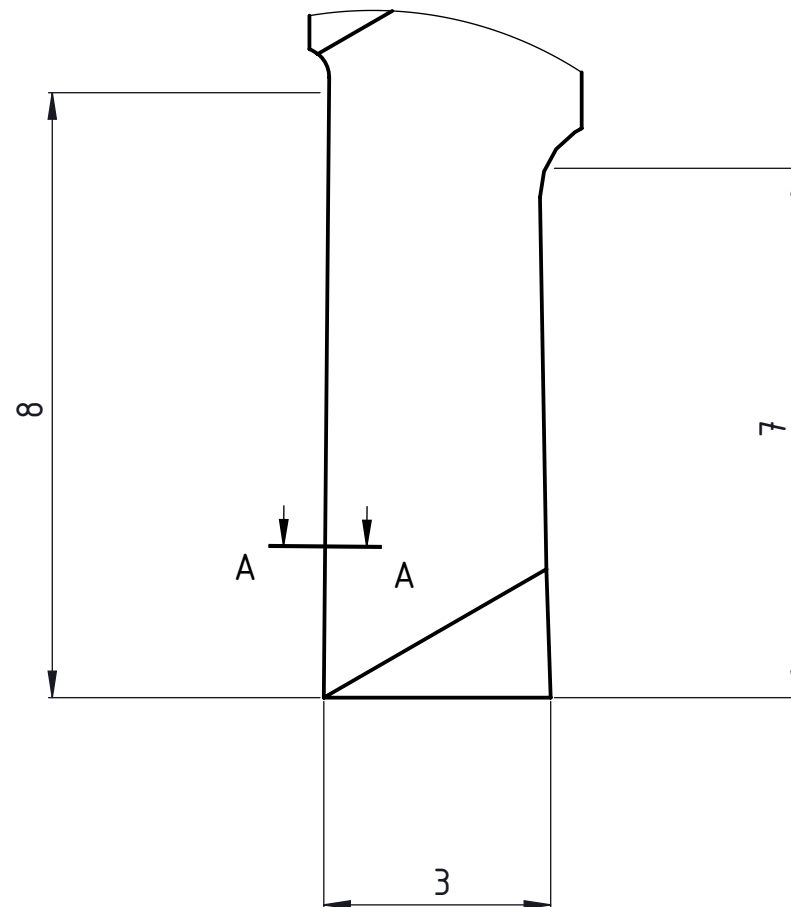

Linke Ausführung  
 Execution gauche  
 Left execution

Beschreibung

multidec CUT-Wendeplatte

Artikel Bezeichnung

3005-3.0-8 L CP

Zeichnungsnummer

CUT-3005-01-24

**UTILIS**<sup>®</sup>  
 Tooling for High Technology

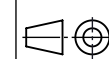

Index  
 -