

1 2 3 4 5 6

A

B

C

D

A

B

C

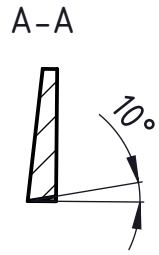
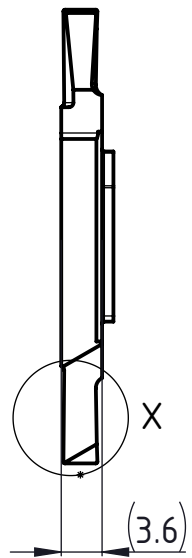
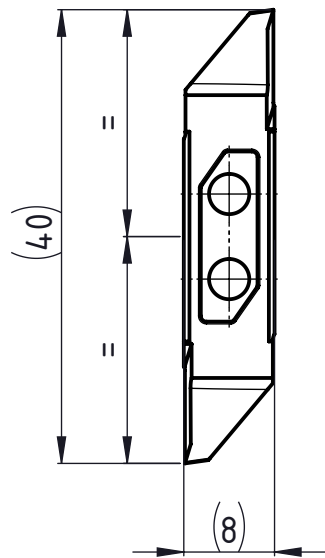

D

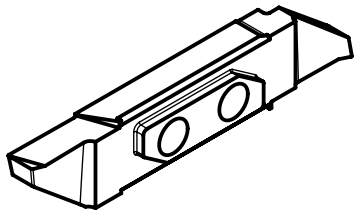
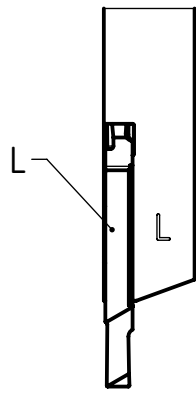
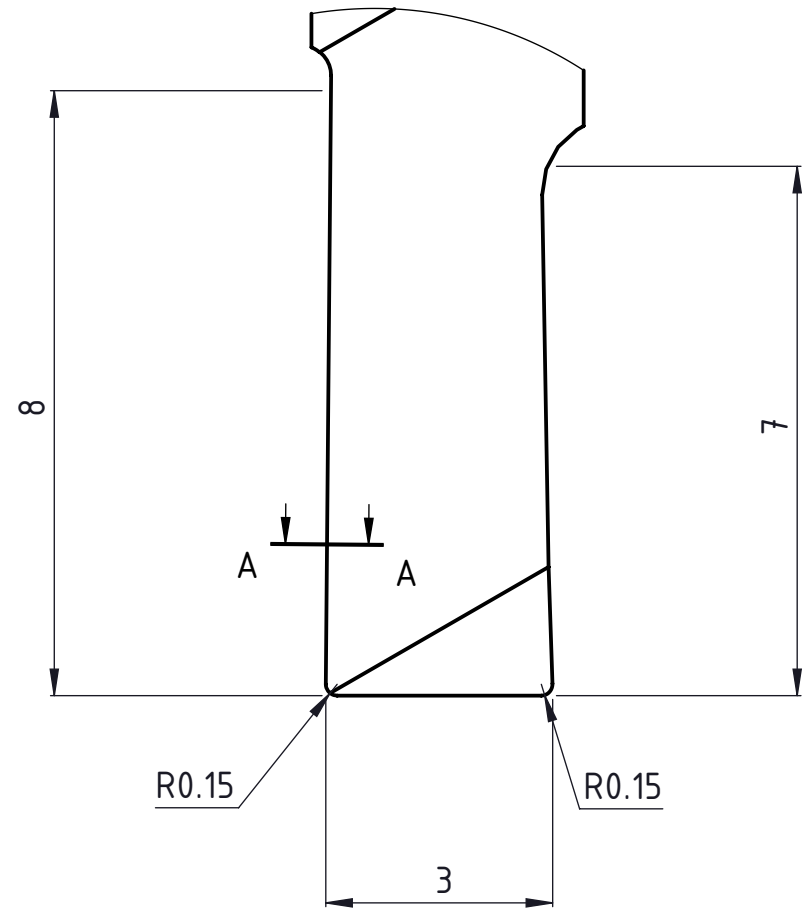

X (10 : 1)



Linke Ausführung  
 Execution gauche  
 Left execution

Beschreibung <b>multidec CUT-Wendeplatte</b>	Artikel Bezeichnung <b>3005-3.0-8 L CP R15</b>	Zeichnungsnummer <b>CUT-3005-01-28</b>	 <small>Tooling for High Technology</small>	 Index -
---	---	---	---	--