

X (15 : 1)

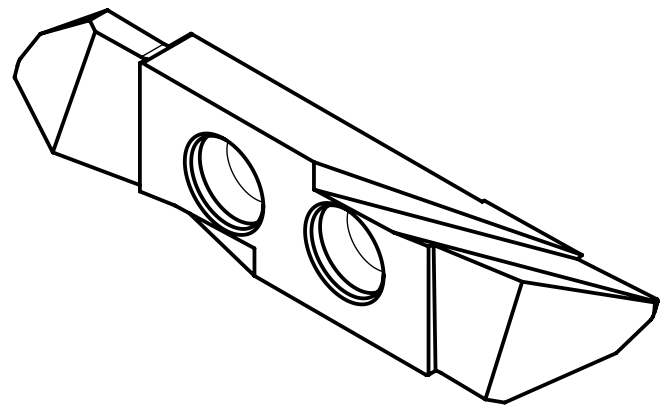
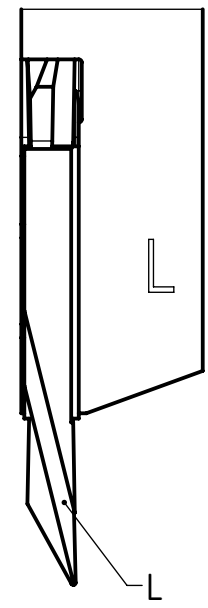
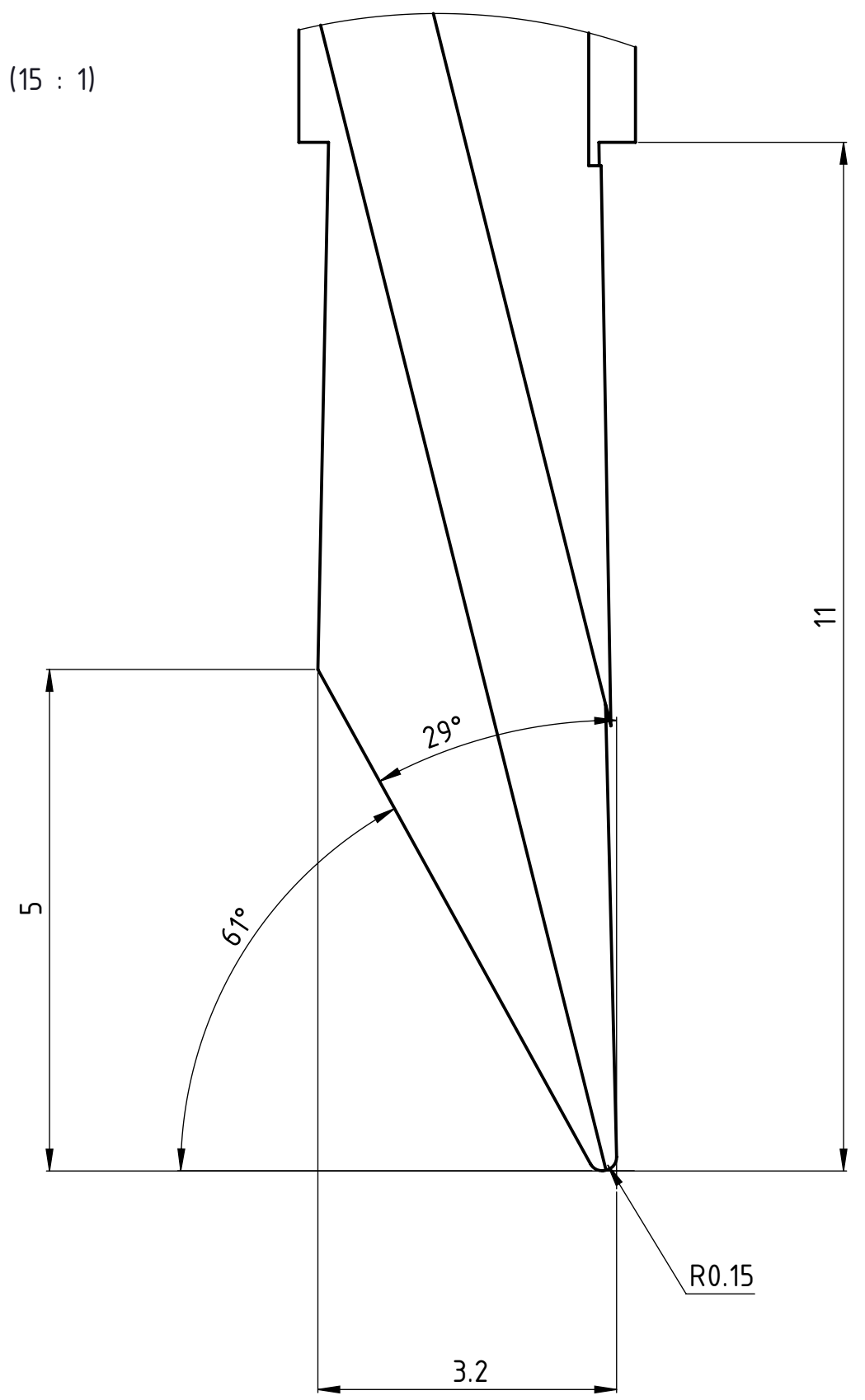

Linke Ausführung
Execution gauche
Left execution

A3-Kunde-V8

Beschreibung
Multidec CUT-Wendeplatte

Artikel Bezeichnung
3004-3.2-6 L SP29015

Zeichnungsnummer
CUT-320-04

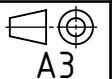

Index
B