

1 2 3 4 5 6

A
B
C
D
A4-Kunde V7

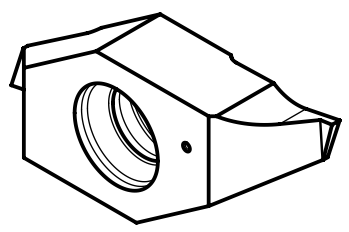
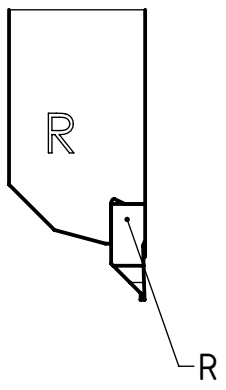
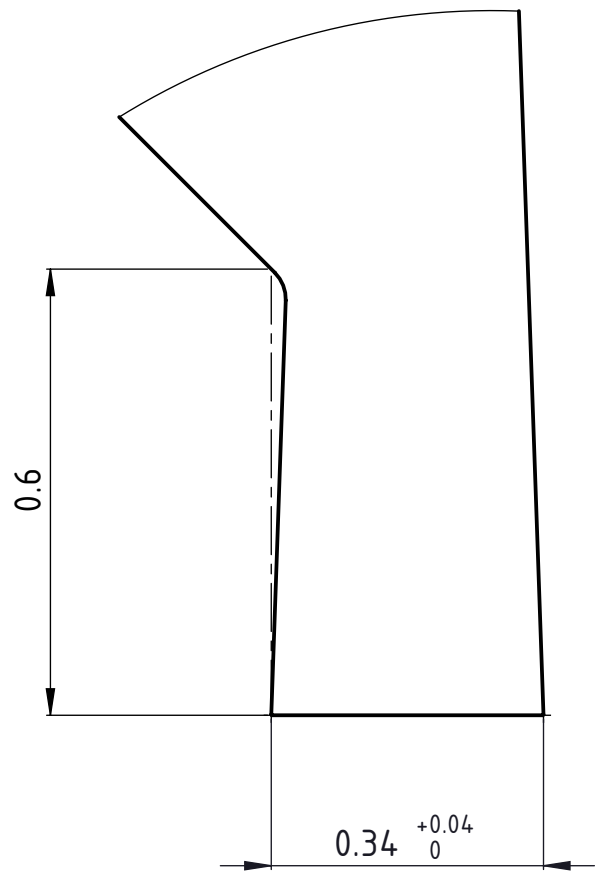
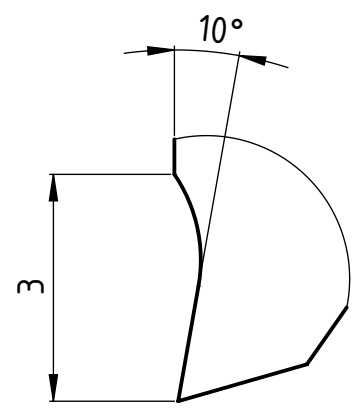
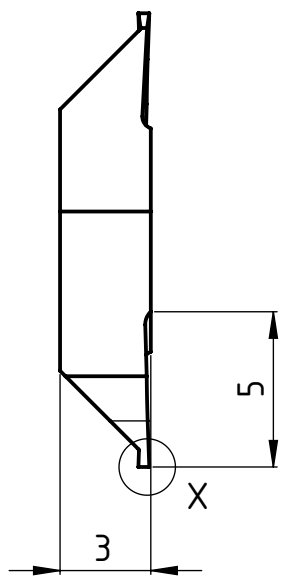
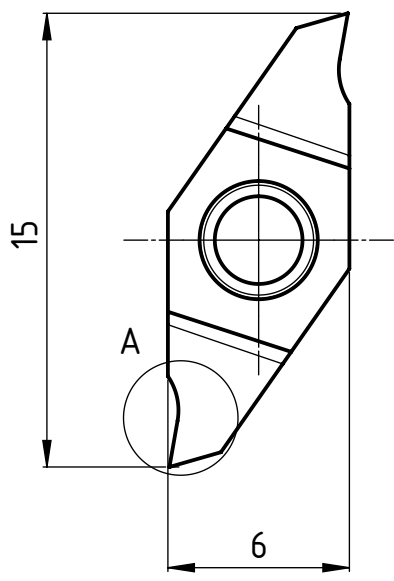

DIN 6799
Rechte Ausführung
Execution droite
Right execution

Freigegeben von am
T.Weilenmann am 25.10.2019
erstellt von am
T.Weilenmann am 16.09.2019

Beschreibung
Multidec CUT-Wendepatte
Artikel Bezeichnung
1610-0.34-0.6 R

UTILIS[®]
Tooling for High Technology
Zeichnungsnummer
CUT-493-01-09

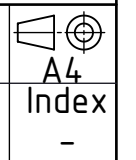
A4
Index
-