

1 2 3 4 5 6

A

B

C

D

A4-Kunde V7

A



B

C

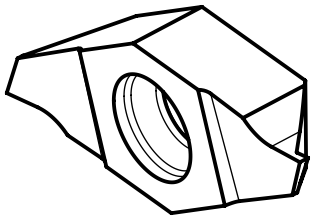
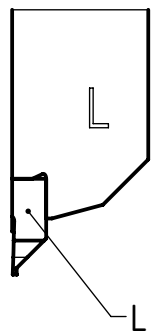
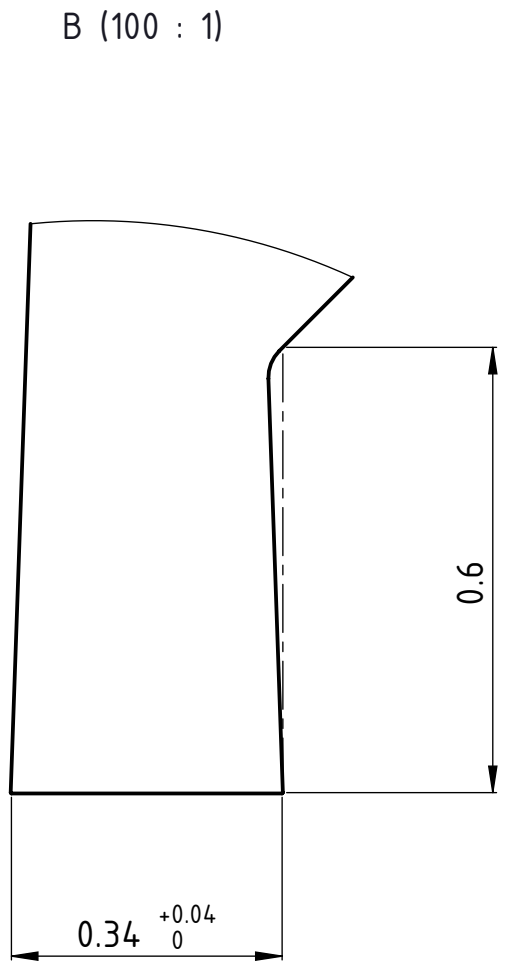
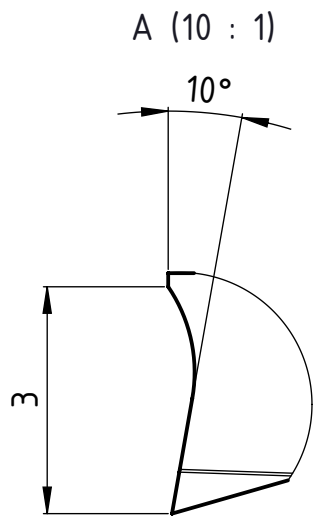
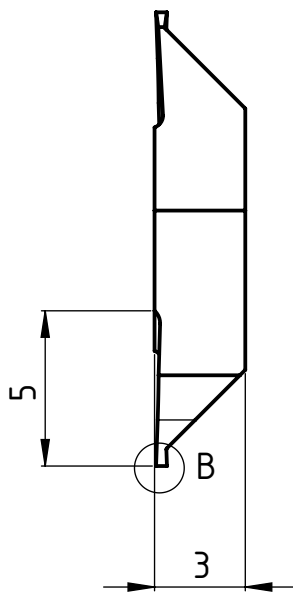
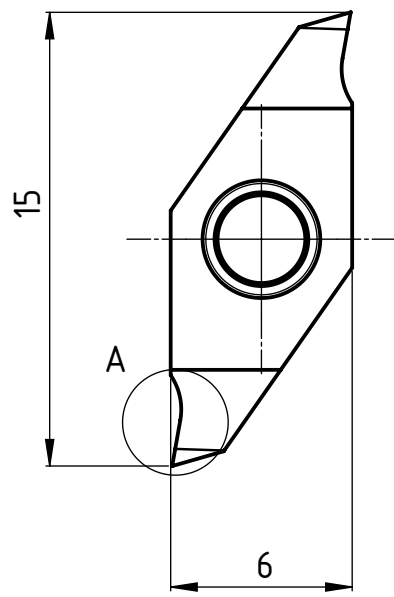
D



DIN 6799
 Linke Ausführung
 Execution gauche
 Left execution

Freigegeben von am T.Weilenmann am 25.10.2019	Beschreibung Multidec CUT-Wendepatte	 Zeichnungsnummer CUT-493-01-10	 A4 Index -
erstellt von am T.Weilenmann am 16.09.2019	Artikel Bezeichnung 1610-0.34-0.6 L		