

1 2 3 4 5 6

A  
B  
C  
D  
A4-Kunde V7

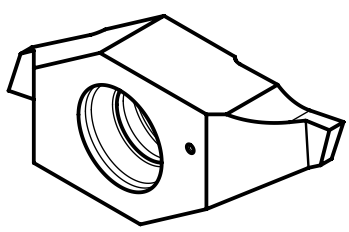
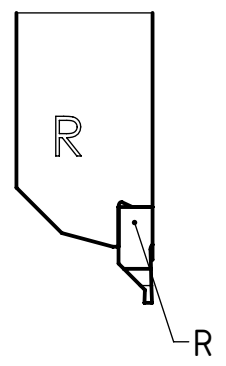
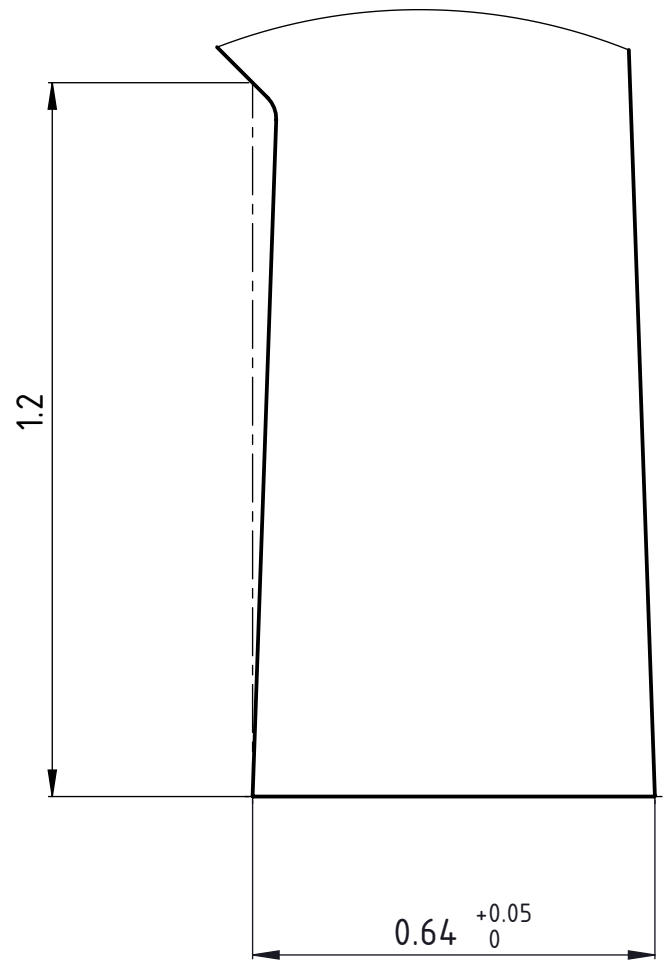
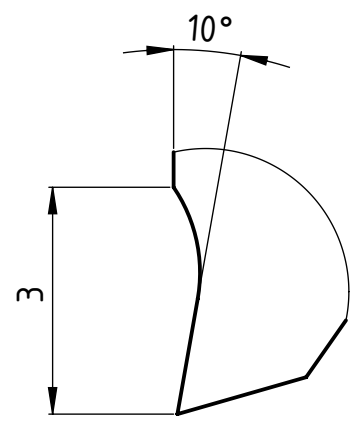
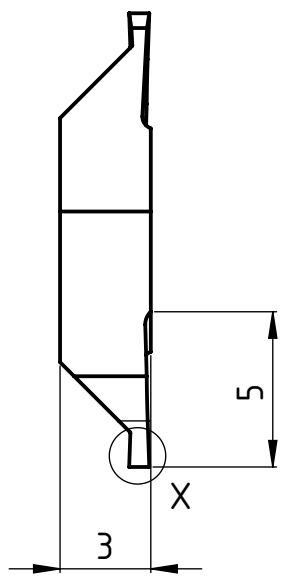
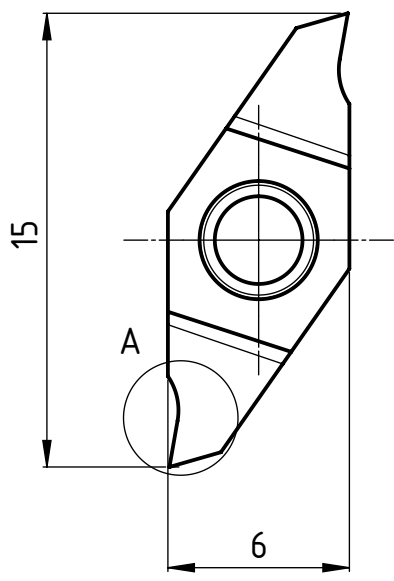

DIN 6799 Rechte Ausführung  
Execution droite  
Right execution

Freigegeben von am

T.Weilenmann am 25.10.2019

erstellt von am

T.Weilenmann am 17.09.2019

Beschreibung

Multidec CUT-Wendepatte

Artikel Bezeichnung

1610-0.64-1.2 R

**UTILIS**<sup>®</sup>  
Tooling for High Technology  
Zeichnungsnummer

CUT-493-01-25

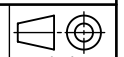
  
A4  
Index  
-