

1 2 3 4 5 6

A

B

C

D

A4-Kunde V7

A

B

C

D

A (10 : 1) X (60 : 1)

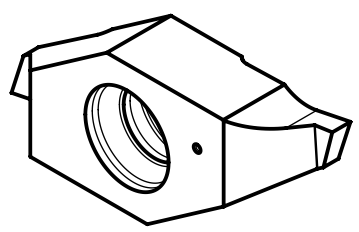
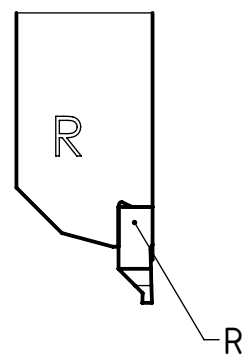
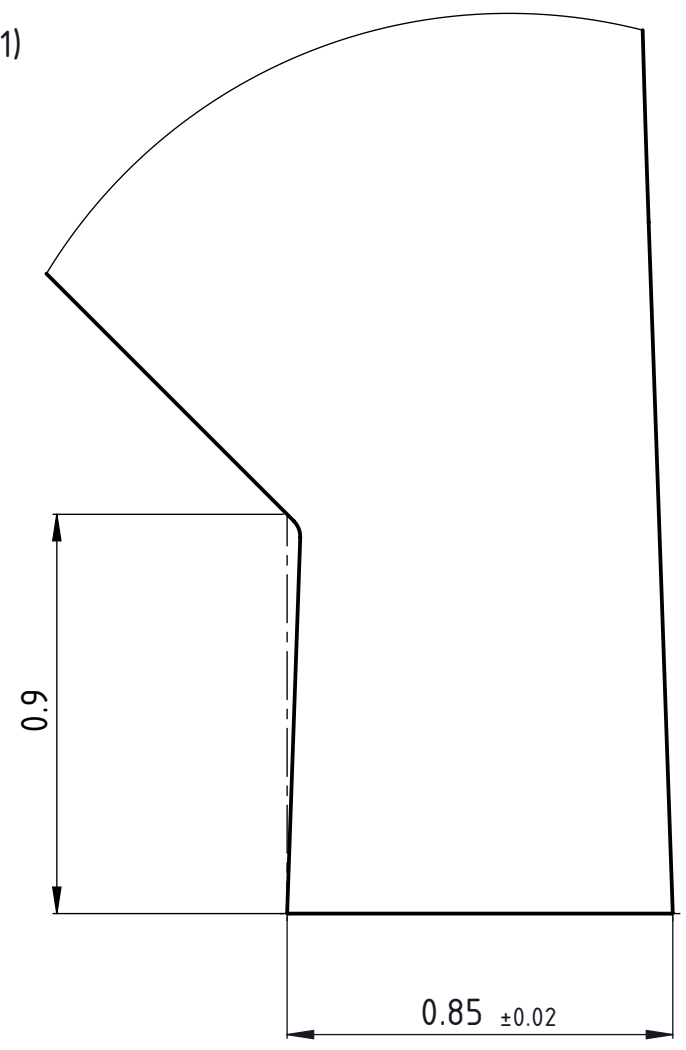
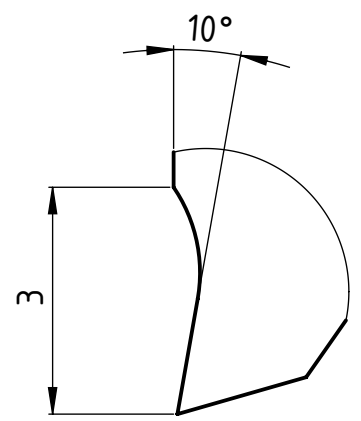
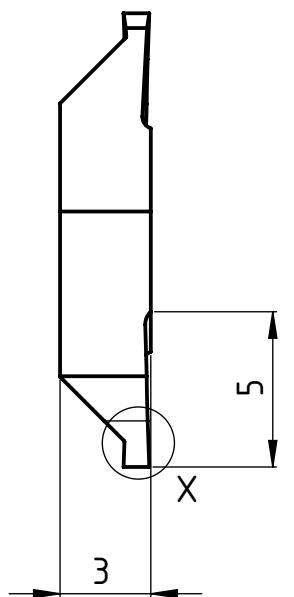
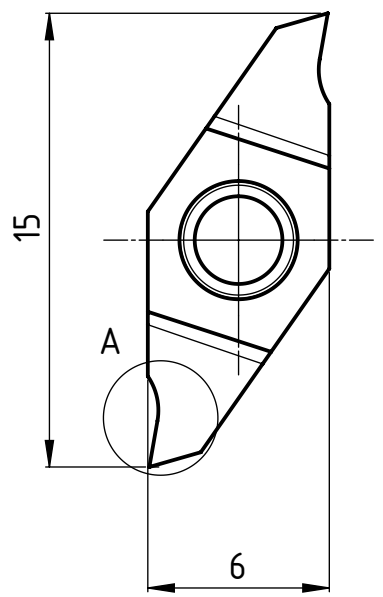

Rechte Ausführung  
 Execution droite  
 DIN 471 Right execution

Freigegeben von am

T.Weilenmann am 25.10.2019

erstellt von am

T.Weilenmann am 17.09.2019

Beschreibung

Multidec CUT-Wendepatte

Artikel Bezeichnung

1610-0.85-0.9 R

**UTILIS**<sup>®</sup>  
 Tooling for High Technology  
 Zeichnungsnummer

CUT-493-01-38

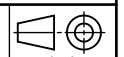
  
 A4  
 Index  
 -