

1 2 3 4 5 6

A

B

C

D

A4-Kunde V7

A

B

C

D

A (10 : 1)

X (50 : 1)

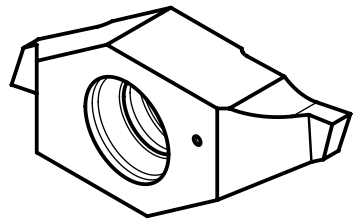
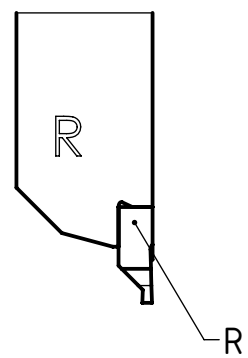
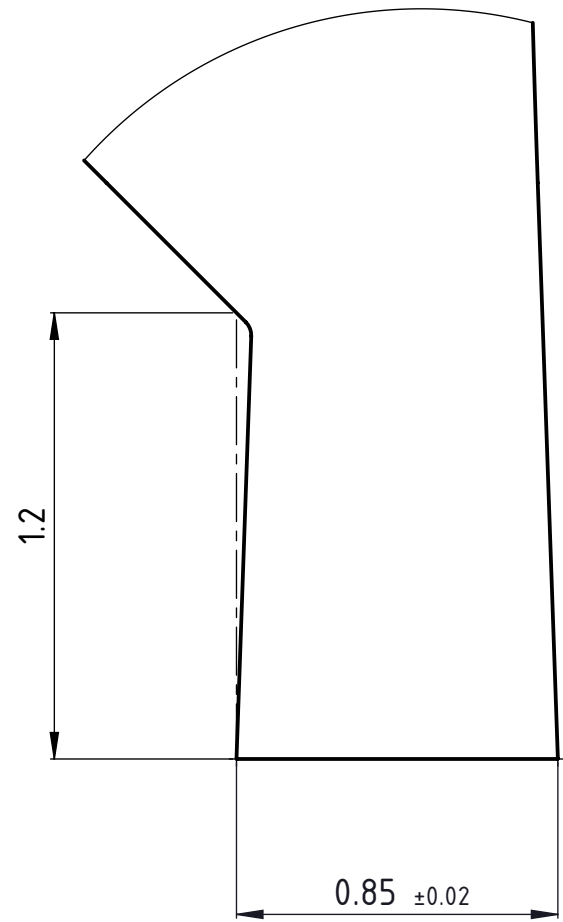
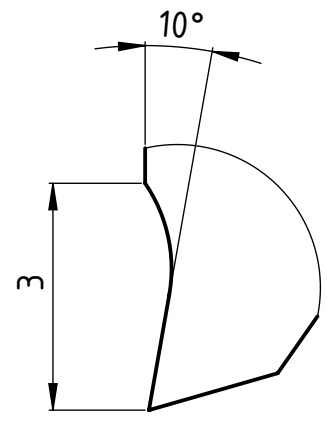
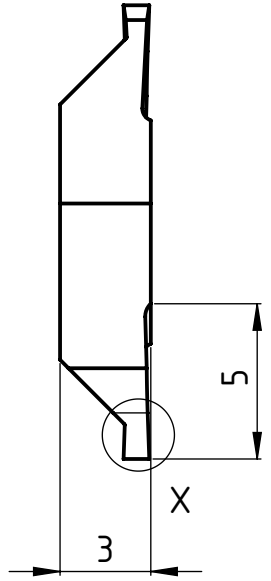
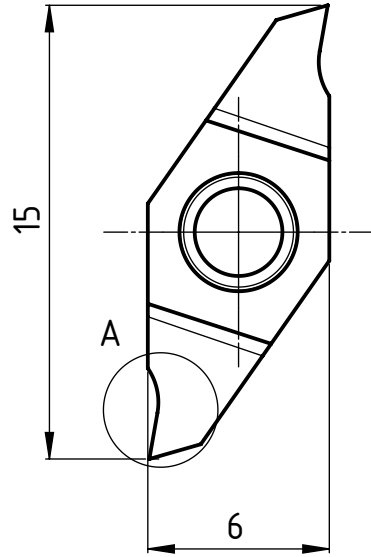

Rechte Ausführung
 Execution droite
 DIN 471 Right execution

Freigegeben von am

T.Weilenmann am 25.10.2019

erstellt von am

T.Weilenmann am 17.09.2019

Beschreibung

Multidec CUT-Wendepatte

Artikel Bezeichnung

1610-0.85-1.2 R

UTILIS[®]
 Tooling for High Technology
 Zeichnungsnummer

CUT-493-01-45

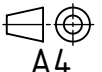

Index
 -