

1 2 3 4 5 6

A

B

C

D

A4-Kunde V7

A (10 : 1)

X (35 : 1)

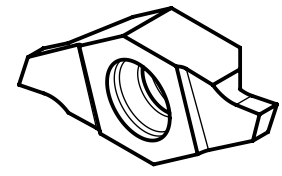
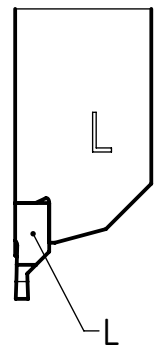
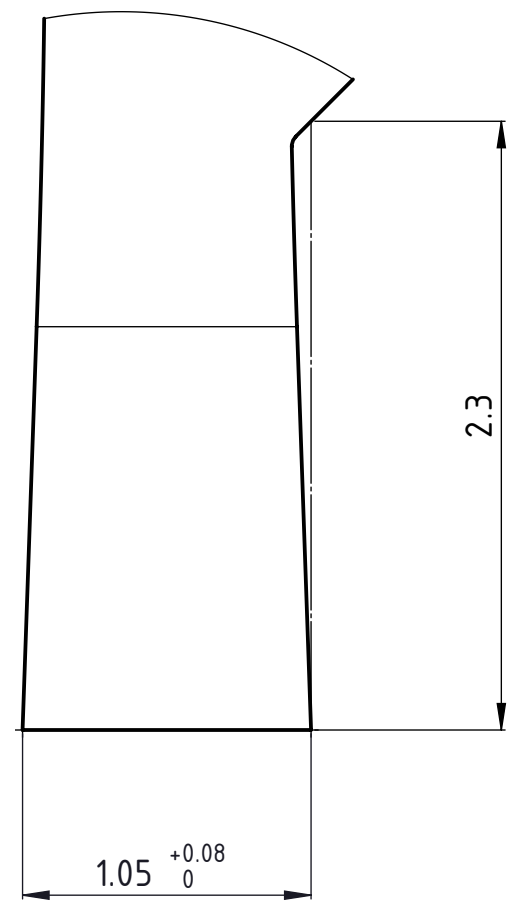
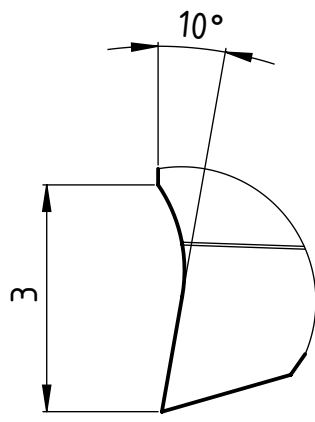
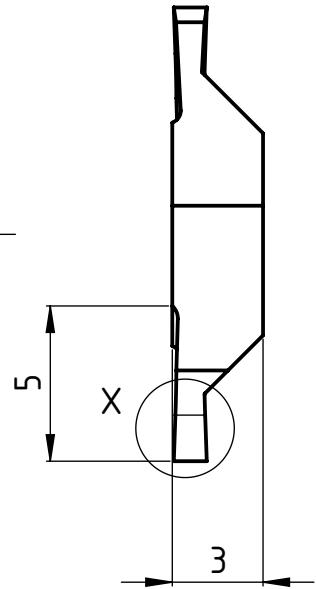
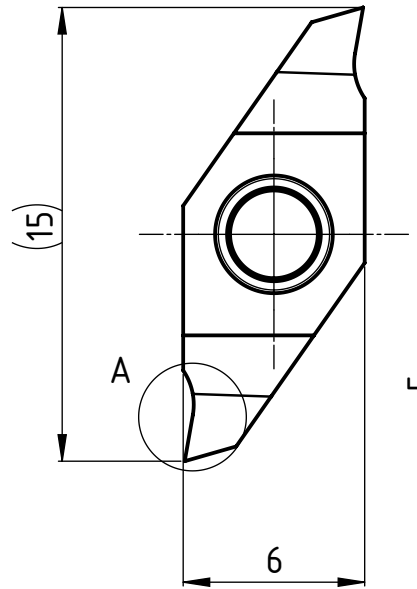

DIN 6799
 Linke Ausführung
 Execution gauche
 Left execution

Freigegeben von am

T.Weilenmann am 25.10.2019

erstellt von am

T.Weilenmann am 18.09.2019

Beschreibung

Multidec CUT-Wendepatte

Artikel Bezeichnung

1610-1.05-2.3 L

UTILIS[®]

Tooling for High Technology

Zeichnungsnummer

CUT-493-02-08

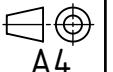

A4

Index

-