

1 2 3 4 5 6

A

B

C

D

A4-Kunde V7

A

B

C

D

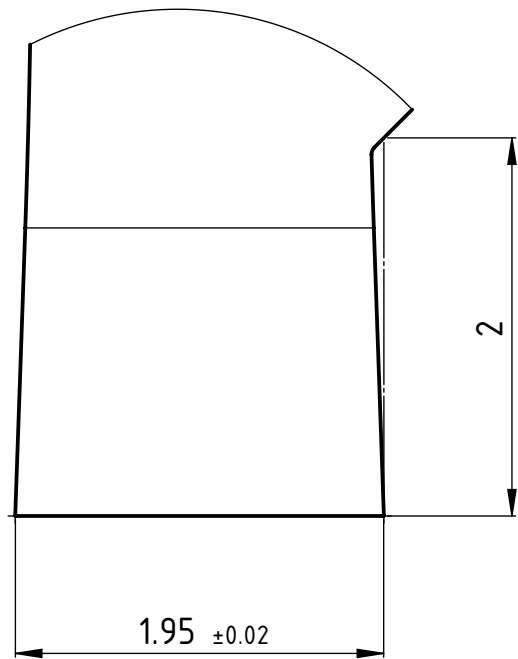
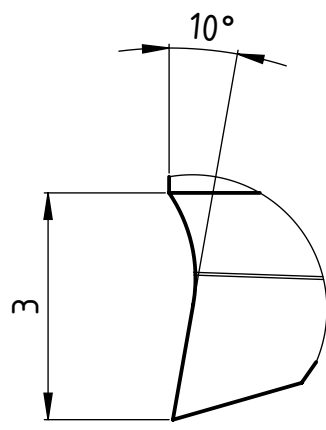
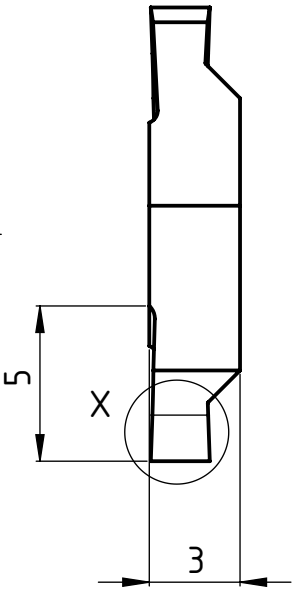
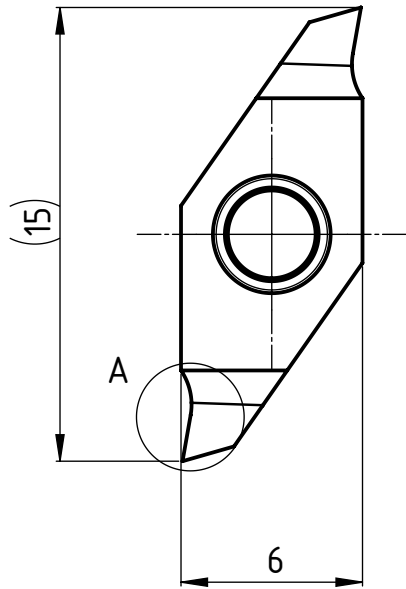

A (10 : 1)

X (25 : 1)

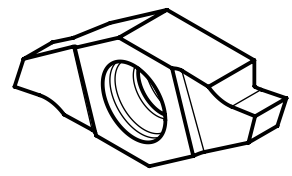
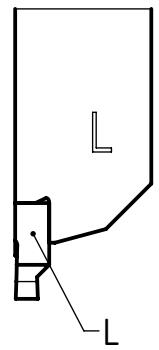

DIN 471 / 472

Linke Ausführung
Execution gauche
Left execution

Freigegeben von am

T.Weilenmann am 25.10.2019

erstellt von am

T.Weilenmann am 18.09.2019

Beschreibung

Multidec CUT-Wendepatte

Artikel Bezeichnung

1610-1.95-2.0 L

UTILIS[®]
Tooling for High Technology
Zeichnungsnummer

CUT-493-02-30

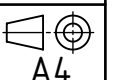

A4
Index
-