

1 2 3 4 5 6

A

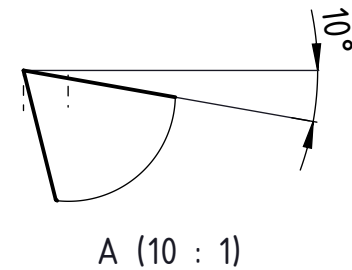

B

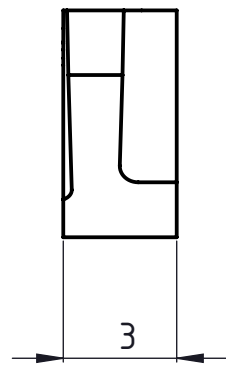
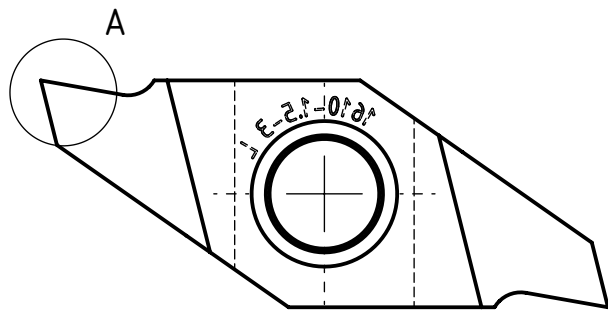
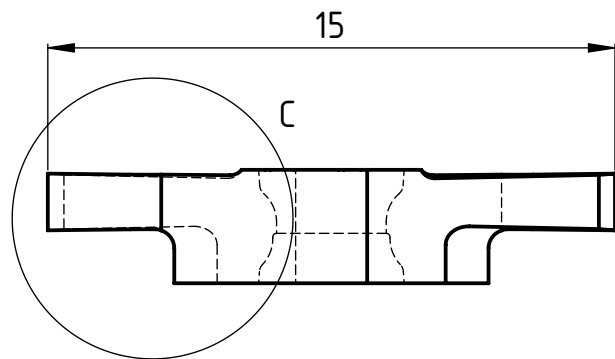

C (20 : 1)

C

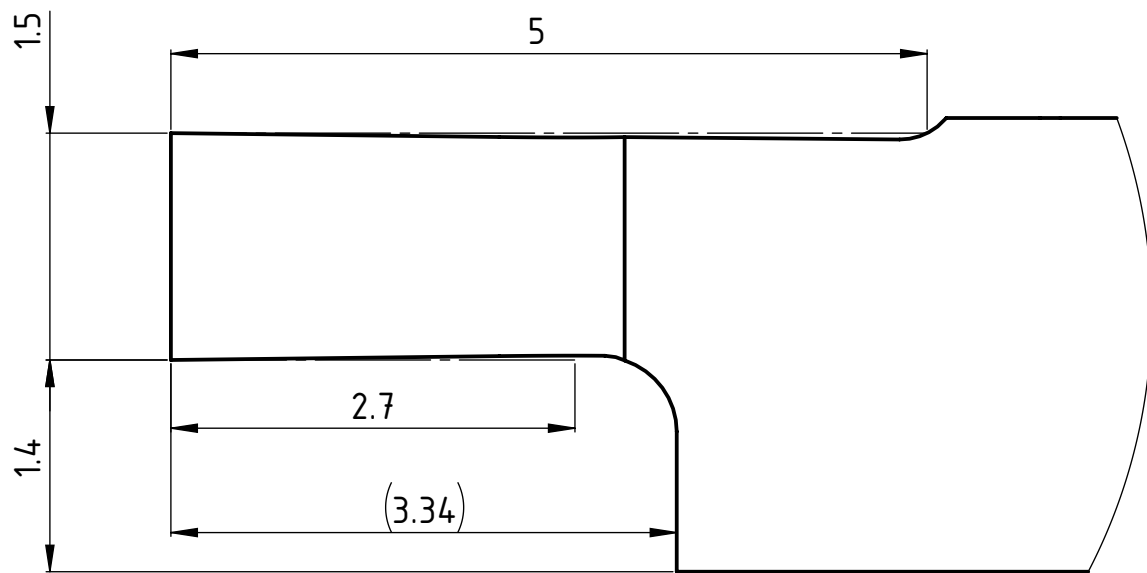

D

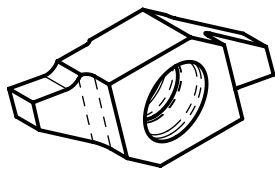

Linke Ausführung abgebildet, Rechte Ausführung CUT-494-19-Z

A4-Kunde V7

Freigegeben von am C.Fabozzi am 12.02.2015
erstellt von am P. Jozic am 12.02.2015

Beschreibung Multidec-Cut Wendepatte
Artikel Bezeichnung 1610-1.5-3 L

<b>UTILIS</b> <small>Tooling for High Technology</small> Zeichnungsnummer CUT-494-20
---

 A4 Index -
---