

1 2 3 4 5 6

X (20 : 1)

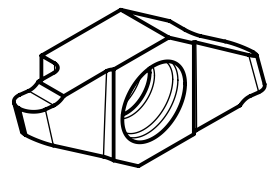
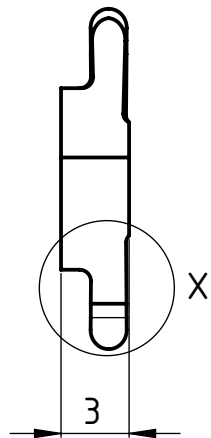
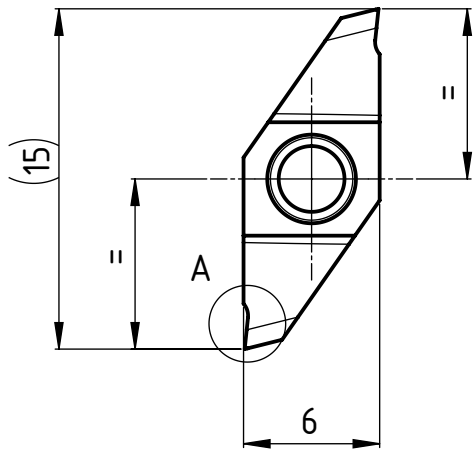

A (10 : 1)

6°

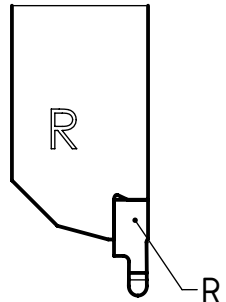
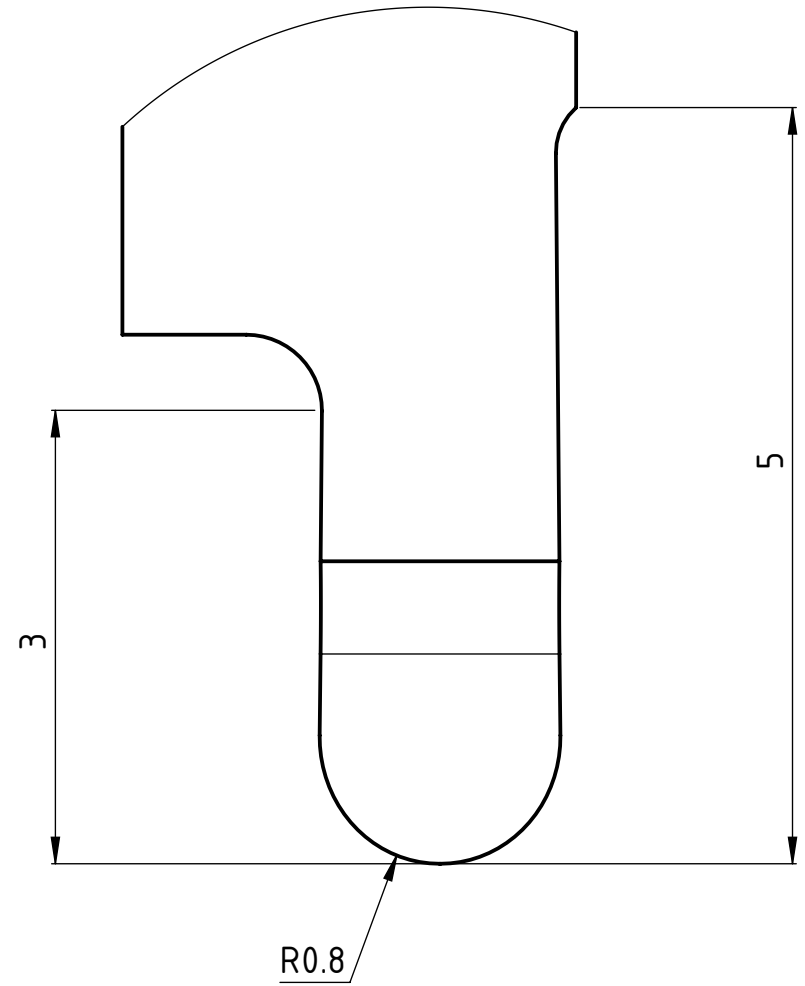
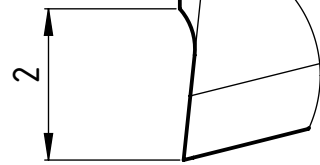

Rechte Ausführung
Execution droite
Right execution

Freigegeben von am

T.Weilenmann am 12.03.2020

erstellt von am

T.Weilenmann am 03.03.2020

Beschreibung

Multidec CUT-Wendepatte

Artikel Bezeichnung

1607-R0.8-3 R

UTILIS[®]

Tooling for High Technology

Zeichnungsnummer

CUT-509-02-23

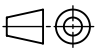

A4

Index

A

A4-Kunde V7