

Linke Ausführung
 Execution gauche
 Left execution

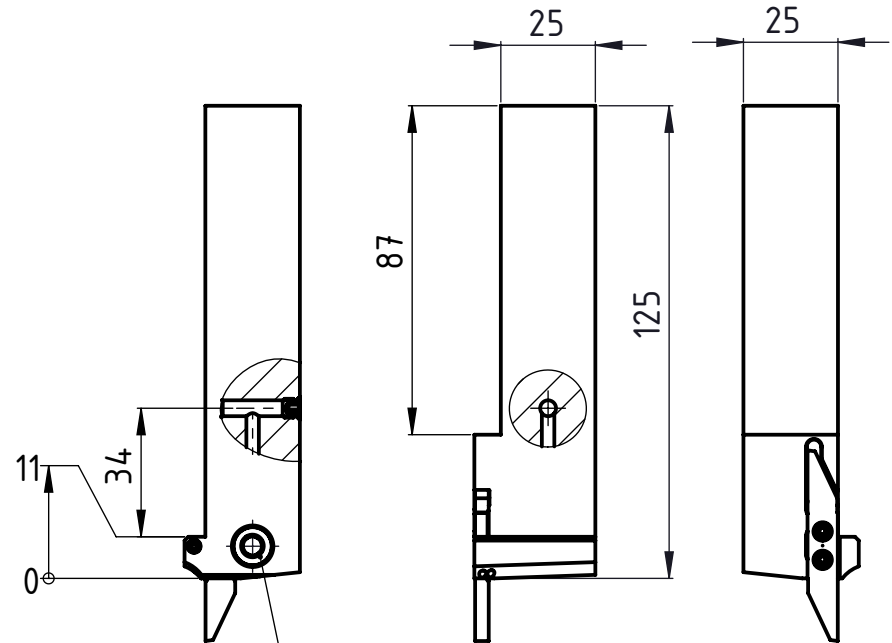

MSP VSR G1/8" IB5

D A4-Kunde-V5

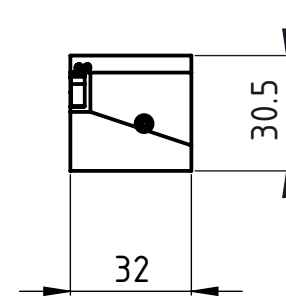
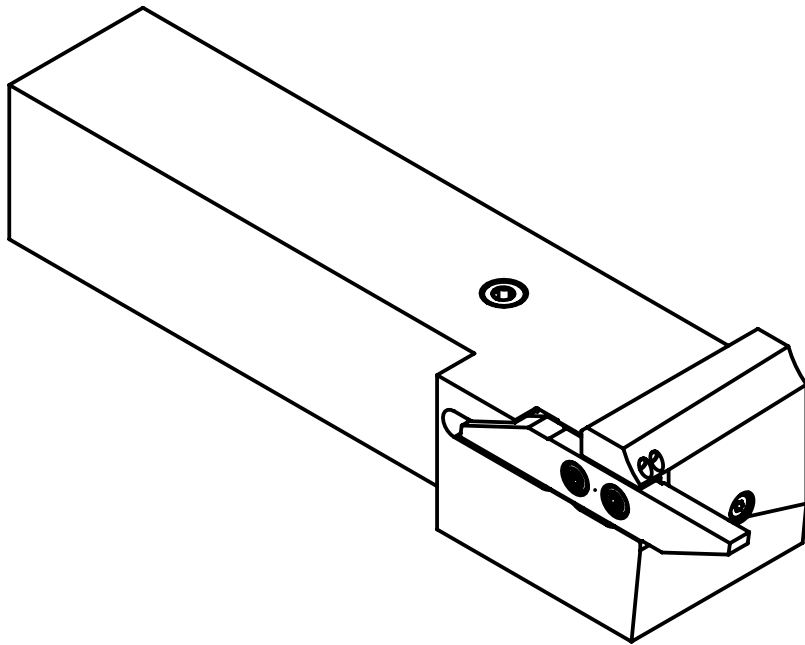

Freigegeben von am
 C.Fabozzi am 15.12.2016
 erstellt von am
 C.Fabozzi am 15.12.2016

Beschreibung
 Multidec-Cut Halter
 Artikel Bezeichnung
 3000-AK-25-125 L IC

Artikel Nr.
 153610

Zeichnungsnummer
 CUT-738-09

