

1 2 3 4 5 6

A

B

C

D A4-Kunde-V5

A

B

C

D

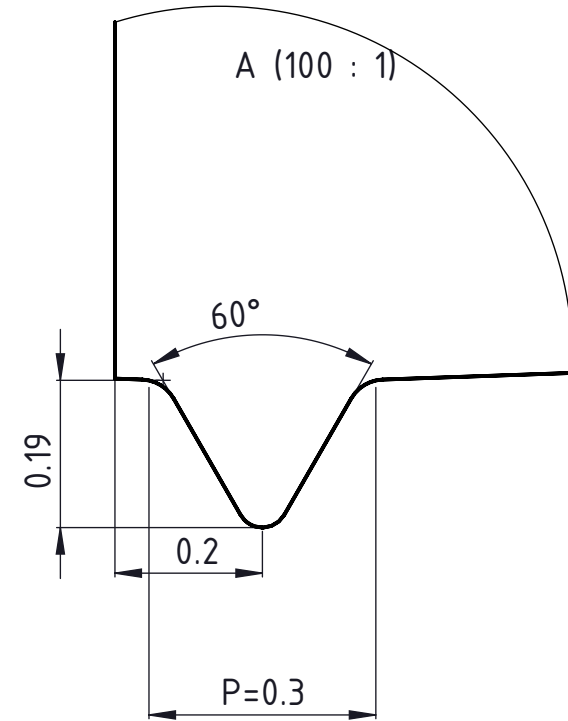
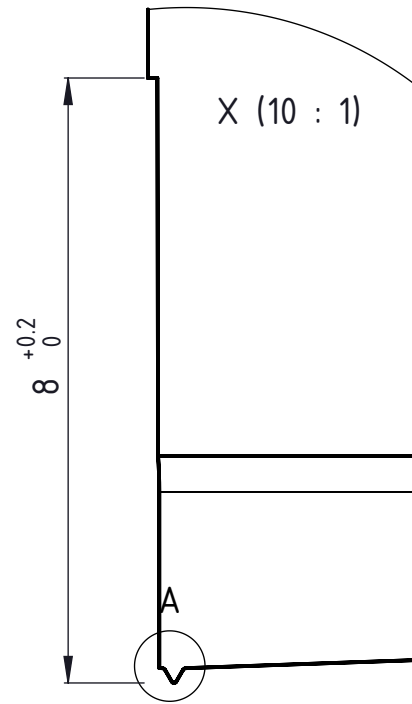
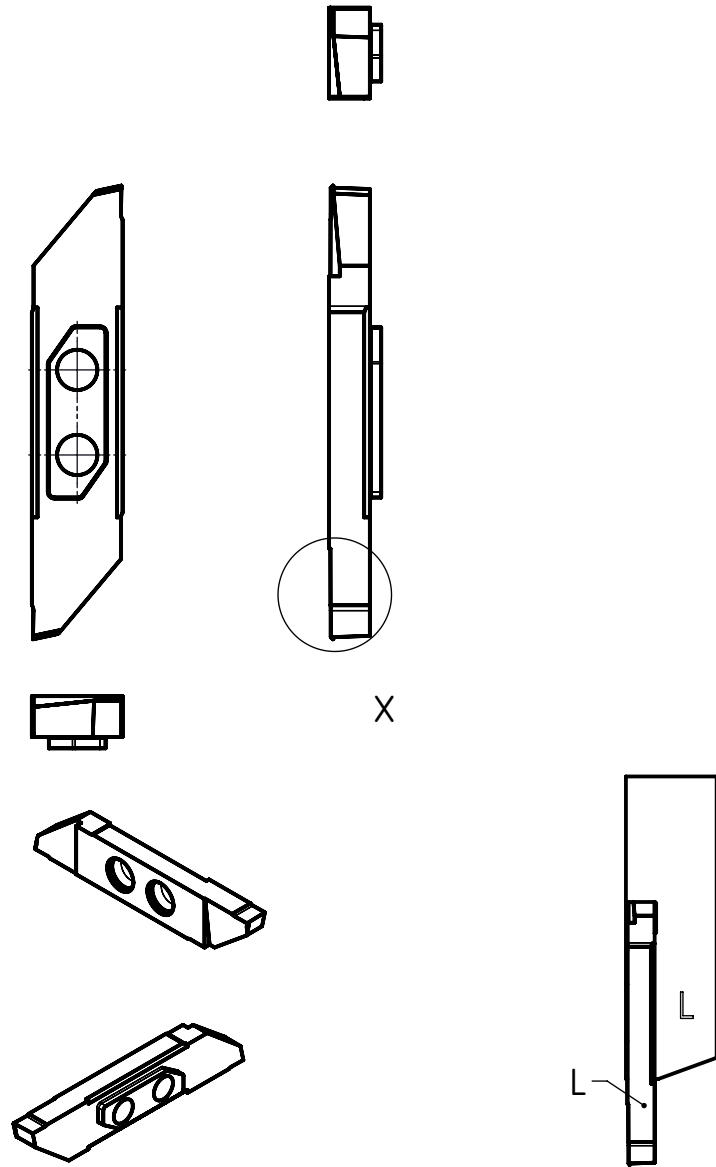

Linke Ausführung
Execution gauche
Left execution



Freigegeben von am
C.Fabozzi am 03.08.2017
erstellt von am
C.Fabozzi am 03.08.2017

Beschreibung
Multidec CUT-Wendepatte
Artikel Bezeichnung
3006 -0.3-60 VP-S L

Zeichnungsnummer
CUT-857-04

