

1 2 3 4 5 6

A

B

C

D

A

B

C

D

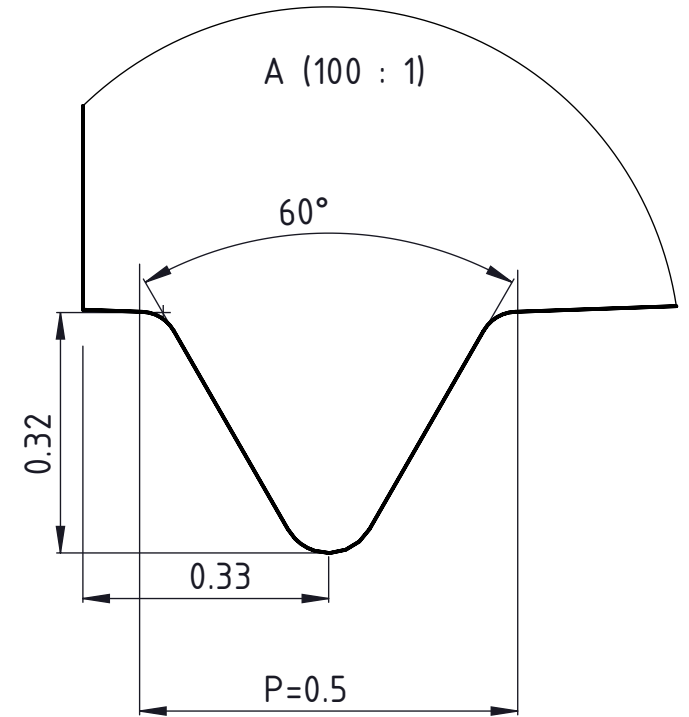
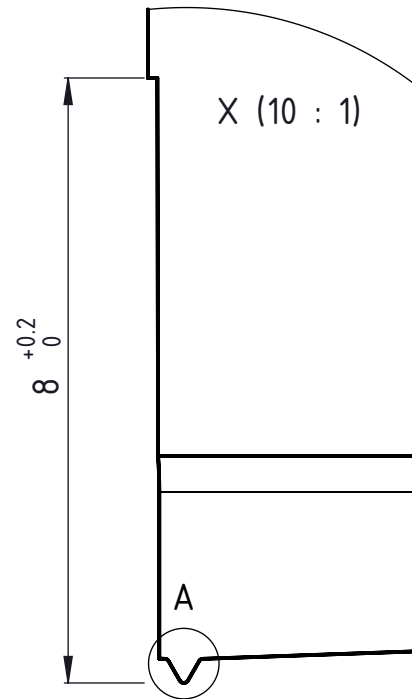
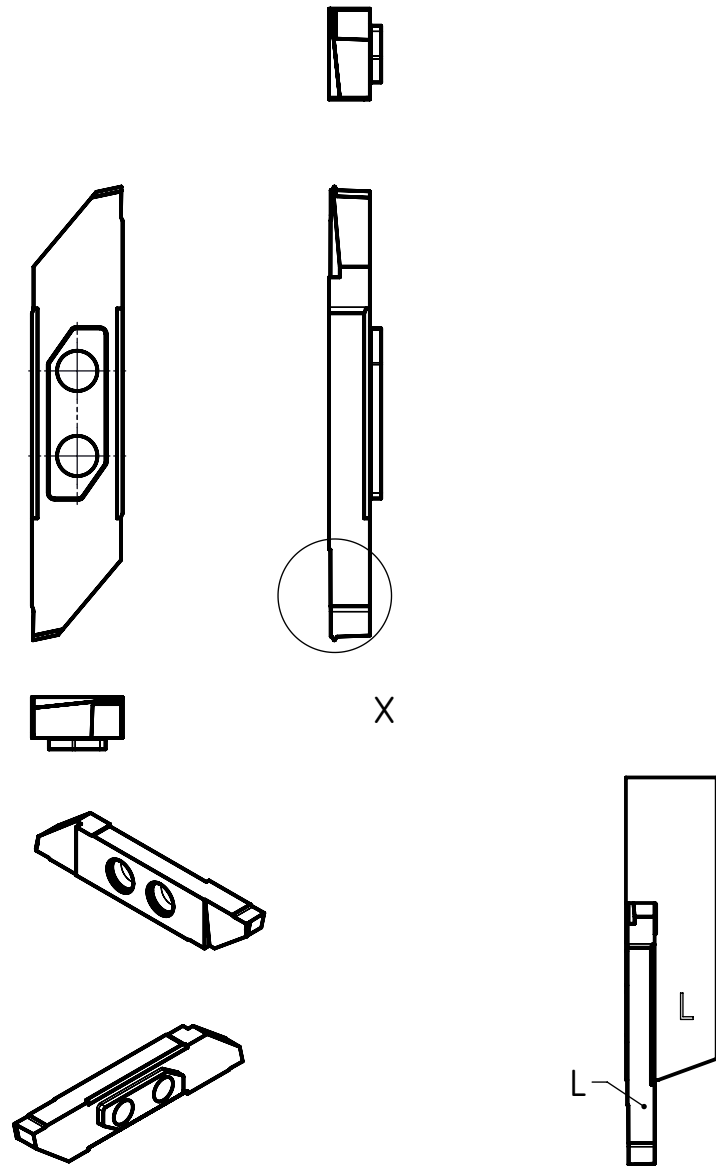

Linke Ausführung  
Execution gauche  
Left execution



Freigegeben von am  
C.Fabozzi am 03.08.2017  
erstellt von am  
C.Fabozzi am 03.08.2017

Beschreibung  
Multidec CUT-Wendepatte  
Artikel Bezeichnung  
3006 -0.5-60 VP-S L

Zeichnungsnummer  
CUT-857-12

