

1 2 3 4 5 6

A

B

C

D A4-Kunde-V5

A

B

C

D

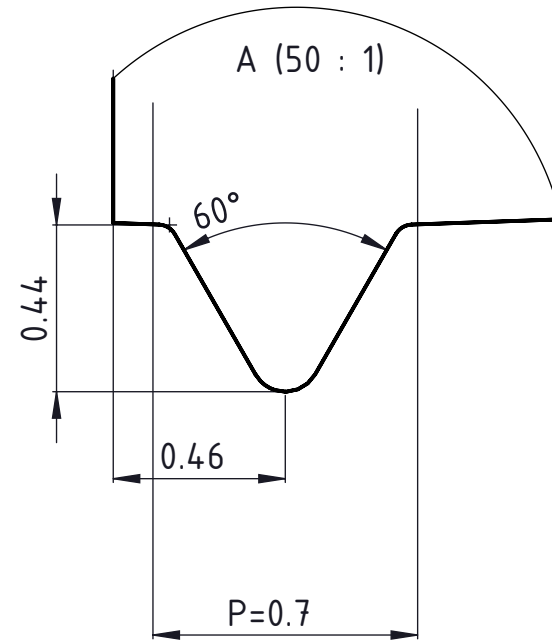
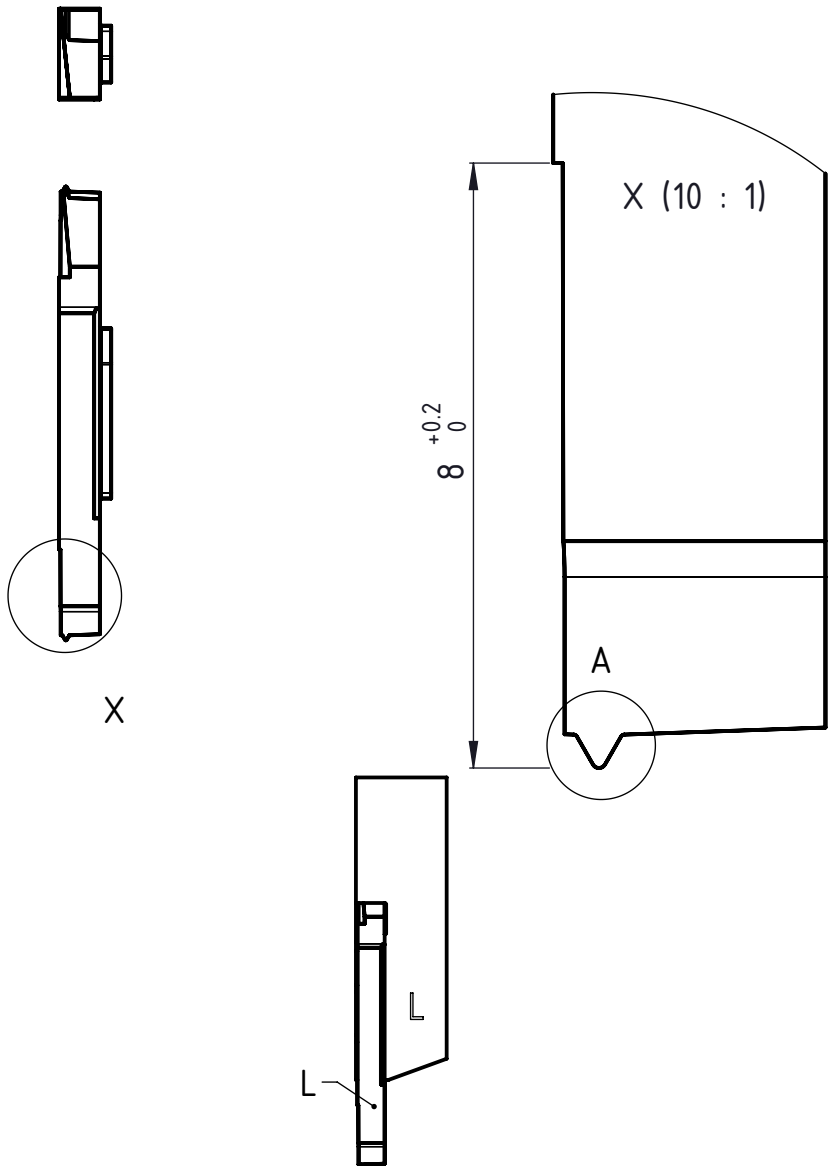
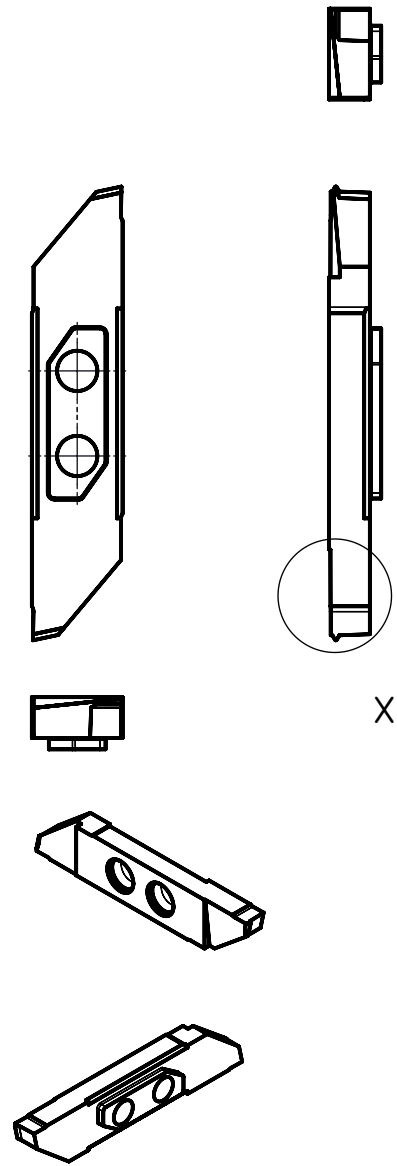

Linke Ausführung
 Execution gauche
 Left execution



Freigegeben von am
 C.Fabozzi am 03.08.2017
 erstellt von am
 C.Fabozzi am 03.08.2017

Beschreibung
 Multidec CUT-Wendepatte
 Artikel Bezeichnung
 3006 -0.7-60 VP-S L

Zeichnungsnummer
 CUT-857-16

